

QST 

# CANADA

Devoted entirely to Canadian Amateur Radio  
Entièrement consacré à la radio amateur canadienne

*Fessenden  
Plaque*

*Restructuring*

*Easy  
Patch*

\$2.50  
October  
octobre  
1990



 Canada Post  
Postes Canada  
Postage paid / Période payée

Third class / Troisième classe



10596



# New! Talk to the World!

Specifically designed to meet the requirements of DOC's Restructured Amateur Service

**TALK TO THE WORLD**



Canadian Amateur Radio Licensing Manual

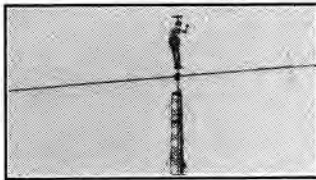

 The Canadian Radio Relay League Inc.

**CHAPTER 6**

## Practical Circuits

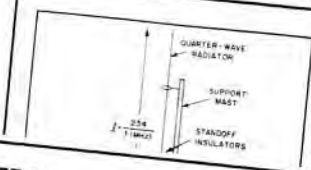

The Quarter-Wave Vertical Antenna

The quarter-wave vertical antenna is popular among amateurs because it requires only one point of support and can be very effective, especially for DX work. See Fig. 8-17. This antenna consists of a vertical radiator a quarter-wavelength long that is used to a number of



## Ham Radio



3 V AC, the rectifier

complete circuits can get. In other words, we are delving deeply into help you gain a basic understanding you with a lot of

ply is shown in Fig. 6-6 to convert the 120- to a little above 13.8 V, it to have but it is the old battery of the type h will operate on 13.8 bile.

ing, as shown by the 8 volts (RMS) to per- a rectifier changes in-

## Check out these important features:

- A comprehensive Training Manual: 13 chapters, over 200 pages
- Study material for all new certificates: Basic, Advanced and Code
- New easy-to-read text, 200 photos, charts and diagrams
- Glossaries of key words
- Chapters on how to choose equipment, set up a station, and eliminate interference
- Operating information useful for the experienced amateur

**Cost: \$20. Order from the CRRL Bookshelf ad in this month's QST Canada, or from your local Amateur Radio dealer.**

**The Canadian Radio Relay League**  
Box 7009, Station E, London, ON N5Y 4J9





QST Canada (ISSN 0840-1670) is published monthly by CRRL Publishing, Inc., to provide radio amateurs, others interested in radio communications and electronics, and the general public with information related to the science of Amateur Radio communications.

## Staff

Harry MacLean, VE3GRO  
Editor

Bob Boyd, VE3SV, Garry Hammond, VE3XN, George Murphy, VE3ERP, Mitch Powell, VE3OT, Dana Shtun, VE3DSS, William Skidmore, VE3AUI, Ray Staines, VE3ZJ, Jack Strangleman, VE3GV  
Contributing Editors

Ray Staines, VE3ZJ  
General Manager

Keith Bentley, VE3DHL  
148 Donhill Cr, Box 96  
Kleinburg, ON L0J 1C0 (416) 893-1984  
Advertising Manager

Butler Graphics  
Lino-tronic Output  
WEBCO Division of Bowes Publishers, Ltd  
Printing and Distribution

## Mailing Address

Box 7009, Station E  
London, ON N5Y 4J9

## Office Location

2025 Richmond Street  
Arva, ON (519) 660-1200

Subscription rates: CRRL membership with QST Canada: \$15 + \$12 = \$27 per year. CRRL membership with QST and QST Canada: \$15 + \$31 + \$12 = \$57 per year. Two- and three-year subscriptions available at multiples of the yearly rates. Copyright © 1990 by CRRL Publishing, Inc.

## ABOUT THE COVER



Here's *glasnost* in action! Valery (Walt) Gromov, UV3GM, contacts stations in the USSR from the shack of VE3XN, during a three-week visit to Canada and the US. (VE3XN photo) ■

# It Seems to Us.../Il nous semble...

## The Future and CRRL

When one considers the future and its impact on CRRL, one is reminded that CRRL's main reason for existence is to serve as *lobbyist* for Amateur Radio. This is the role that has the greatest impact on Amateur Radio. On examining the potential consequences in this area, one wonders why every amateur does not support CRRL and its work.

One immediately thinks of the direct representations CRRL makes to DOC, the Department of Communications. Restructuring and deregulation of mode subbands come to mind. Unnoticed by most amateurs, but probably of far greater importance, are the representations CRRL makes—directly and through the Radio Advisory Board of Canada—concerning RF interference. We want the Minister of Communications to use the power of his new Radio Act to put responsibility for interference problems on the shoulders of those who cause them: the manufacturers of improperly designed products. Of course, the electronics industry has vast resources at its disposal, while CRRL's resources are more modest. If amateurs fail to get behind CRRL with solid support we may make only very slow progress in this area.

Internationally, CRRL supports the International Amateur Radio Union, by paying an annual levy (calculated on the total number of Canadian amateurs, not just on those who are CRRL members) and special levies for special situations, and by finding and by persuading knowledgeable Canadian amateurs to volunteer their time and talent to help find solutions for problems that face Amateur Radio worldwide. At the moment, Amateur Radio is preparing for two major World Administrative Radio Conferences (WARCs), one in 1992, and another in 1993. Unlike at WARC '79, there is little chance of gaining new amateur bands. Instead, there is potential for actually losing bands, or for having other services share bands with us. The 40-metre band could be impacted. As a result of decisions at the WARCs, our 40-metre band could be moved, it could be reduced to the same bandwidth as in Europe, or it could even be lost worldwide. In addition, all of our VHF/UHF bands are under some threat—particularly our 2-metre band.

Back at home, Amateur Radio is under attack from a different quarter. Just at a time when DOC gives us a Restructured Amateur Service with all its potential, the federal government gives us a Goods and Services Tax (GST). The greatest problem with GST is its psychological impact on individuals. Faced with thought of the

new tax, many individuals will begin to cut their purchases of non-essentials. Are we likely to attract new amateurs in this climate? What will be DOC's reaction when the number of new licensees fails to reach their projections? Will they put the blame where it belongs, or will they conclude that Canadians are not interested in Amateur Radio? If they reach the latter conclusion, where will the resistance be when a Canadian parcel service asks for a chunk of our VHF bands?

This same GST could have a direct impact on CRRL. CRRL's financial support could be reduced just at a time when financial needs reach a peak. If large numbers of CRRL members began to visualize their CRRL memberships as non-essential, and they began to forgo their memberships to help pay GST on other products, CRRL could be rendered impotent from lack of funds.

It is a strange irony that at the very time that a financially strong CRRL is particularly needed, both domestically and internationally, monetary considerations having nothing to do with Amateur Radio threaten it. The problem is compounded by the fact that CRRL will have to pay the GST on the goods and services it requires.

To minimize the effect of the GST as much as possible, CRRL has revised its membership structure. Along with food, medical services and other essentials, your CRRL membership will *not* be taxable. The magazines, which will be taxable, are now *optional*. We're hoping that you will agree that the future of Amateur Radio—in Canada and worldwide—is worth supporting, and that you will continue your CRRL membership even if you choose to drop the magazines for a while.

For the next couple of years we expect that CRRL's primary concern will be the WARCs. Domestic concerns, while vitally important, will probably play a secondary role, particularly if there is insufficient funds to do justice to both. If you agree that this is undesirable, you can help. Persuade all your amateur friends to take out or renew CRRL membership now, for only \$15 tax-free dollars a year. If every current member signed up *one* new member, potential financial problems would be reduced and a lot more could be done. If every current member signed up *two* new members, there would be no financial problems and everything could be done! CRRL could meet all of Canada's international obligations, and continue to deal effectively with matters at home as well. —Ray Staines, VE3ZJ, CRRL General Manager ■



All letters are considered carefully. Letters are edited and may be condensed in order to have more information and readers' views presented. The publishers of *QST Canada* assume no responsibility for statements made by correspondents.

## BURNABY "LOONEY LOTTERY"

I read your article, "Getting Serious About WARC" (1990 September *QST Canada*) with great interest. In Burnaby ARC, we searched for a way to make a substantial contribution. We have about 130 members. We felt we could contribute \$1000.

Thus, the "Looney Lottery". To raise \$1000, we are really raising \$1400. The extra \$400 is for a handheld radio to be won by a member of our club when we reach our goal.

Every time you contribute a "looney" to the fund, your call goes on a draw ticket. To be eligible for the prize, you must be a paid-up member of the club at the

time of the draw. This way, we ensure that the prize remains within the club.

Since June, we have raised over \$500, and the busy club season is just starting. We think we can reach our goal by Field Day, 1991. If thirty clubs across Canada raised \$1000 this way, Amateur Radio would be well represented at WARC.  
—Lou Beaubien, VE7CGE, Burnaby, BC

## RENEW NOW

I think it would be a good idea to make it plain to CRRL members that they should renew their membership soon to avoid the GST. How many years can be paid ahead?

—Bill Hardie, VE3EFX, Kincardine, ON

*Any number of years can be prepaid. Originally, the government was going to charge GST on all magazine subscriptions taken out after 1990 September 1. New date for charging GST on subscriptions is 1991 January 01.* ■

# Calendar



**Attention:** Deadline for items is the 20th of the second month preceding month of publication. For example, information should reach *QST Canada* by January 20 to be included in a March issue.

**CRRL Fall Sprints:** 902-3456 Mhz: September 27-28, 432 Mhz: October 4-5, 220 Mhz: October 9-10, 144 Mhz: October 15-16, 50 Mhz: October 27-28. For complete details, see rules in 1990 September *QST* and *QST Canada*.

**Greenwood, NS:** 2nd Annual Fleamarket, Saturday, October 20, 0900-1500 at Gillwell Hall. Sponsored by Greenwood ARC. Admission: \$2 Talk-in on VE1WN, 146.67 MHz (-), and on 146.52-MHz simplex. For more information, contact Lance Peterson, VE1VCL, Box 63, Greenwood NS B0P 1N0.

**London, ON:** 13th Annual Fleamarket, Sunday, October 14 at the Pot O'Gold Bingo Palace, Hamilton and Gore Rds. Sponsored by London ARC. Large indoor sales area, snack bar. Opens 0900, 0800 for vendors. Tables: \$5. Admission: \$4, children 14 and under free. Talk-in on VE3LON, 147.06 MHz (+). For more information, contact Dave Noon, VE3IAE, Box 82, Station B, London, ON N6A 4V3, Tel (519) 453-2292.

**Jamboree-on-the-Air:** 33rd Boy Scouts Jamboree-on-the-Air, 0000 local time, Saturday, October 20, to 2400 local time, Sunday October 21. An opportunity to introduce scouts to Amateur Radio and permit them to communicate with other scouts. Call "CQ Jamboree". Agreed World Scout Frequencies: 3.59, 7.03, 14.07, 21.14 and 28.18-MHz CW, and 3.74, 3.94, 7.09, 14.29, 21.36 and 28.99-MHz phone. ■

## The Canadian Radio Relay League, Inc La Ligue Canadienne de la Radio Amateur, Inc



The Canadian Radio Relay League (CRRL) is a noncommercial association of radio amateurs organized for the promotion of Amateur Radio communications and experimentation, for the establishment of networks to provide communications in the event of disasters or other emergencies, for the advancement of the radio art and the public welfare, for the representation of radio amateurs in legislative and other matters, and for the maintenance of fraternalism and a high standard of conduct.

CRRL is incorporated under the Canada Corporations Act. Its affairs are governed by a seven-member Board of Directors elected every two years by the CRRL general membership. CRRL is noncommercial, and no one who could gain financially by the shaping of its affairs is eligible for membership on its Board.

CRRL is the Canadian member-society of the International Amateur Radio Union (IARU). "Of, by and for the Canadian Radio Amateur", CRRL numbers within its ranks the vast majority of active amateurs in the nation and has a proud history of achievement in amateur affairs.

A bona fide interest in Amateur Radio is the only essential requirement for membership. An Amateur Radio licence is not required, although full voting membership is granted only to licensed amateurs in Canada.

Membership inquiries and general correspondence should be directed to CRRL Headquarters, Box 7009, Station E, London, ON N5Y 4J9 (519) 660-1200.

### Officers and Directors

**President:** Bruce Balla, VE2QO  
CP 876, Succ B, Montreal, PQ H3B 3K5  
(514) 623-1303

### Honorary Vice Presidents:

Thomas Atkins, VE3CDM  
Noel Eaton, VE3CJ

**Vice President:** Harry MacLean, VE3GRO  
500 Riverside Dr, London, ON N6H 2R7  
(519) 473-1668

**Vice President:** Dana Shtun, VE3DSS  
500 Willard Ave, Toronto, ON M6S 3R6  
(416) 763-1761

**Vice Pres Int'l Affairs:** George Spencer, VE3AGS  
R R 1, Jordan, ON L0R 1S0  
(416) 562-4891

**Secretary-Treasurer:** William Loucks, VE3AR  
155 Brentwood Rd N, Toronto, ON M8X 2C8  
(416) 231-8474

**Alberta Director:** Ken Oelke, VE6AFO\*  
7136 Temple Dr NE, Calgary, AB T1Y 4E7  
(403) 280-5340

**Atlantic Director:** Carl Anderson, VE1UU\*  
25 Lawnsdale Dr, Dartmouth, NS B3A 2N1  
(902) 469-9756

**Quebec Director:** Pat Franklin, VE2EDO\*  
51 Bayview Ave, Point Claire, PQ H9S 5C4  
(514) 695-5873

**Ontario North Director:** Raymond Perrin, VE3FN\*  
128 Withrow Ave, Nepean, ON K2G 3N7  
(613) 225-8132

**Ontario South Director:** George Gorsline, VE3YV\*  
118 MacPherson Ave, Toronto, ON M5R 1W8  
(416) 921-4214

**Midwest Director:** Dave Snydal, VE4XN\*  
25 Queens Cr, Brandon, MB R7B 1G1  
(204) 728-2463

**Pacific Director:** David Fancy, VE7EWI\*  
14455 104A Ave, Surrey, BC V3R 1R2  
(604) 584-6517

### Section Managers

**Alberta:** William Gillespie, VE6ABC  
10932 68th Ave, Edmonton, AB T6H 2C1  
(403) 438-2510

**British Columbia:** Ernest Savage, VE7FB  
4553 West 12th Ave, Vancouver, BC V6R 2R4  
(604) 224-5226

**Manitoba:** William G Crooks, VE4JR  
431 Hillary Cr, Winnipeg, MB R2Y 0Z1  
(204) 837-9509

**Maritimes-Newfoundland:** Carl Anderson, VE1UU  
25 Lawnsdale Dr, Dartmouth, NS B3A 2N1  
(902) 469-9756

**Ontario:** Larry Thivierge, VE3GT  
34 Bruce St W, Renfrew, ON K7V 3W1  
(613) 432-5967

**Quebec:** Harold Moreau, VE2BP  
80 rue Principale, St-Simon Co, Bagot, PQ J0H 1Y0  
(514) 798-2173

**Saskatchewan:** Bruce Rattray, VE5RC  
128 Durham Dr, Regina, SK S4S 4Z2  
(306) 584-2059

### Staff

**General Manager:** Raymond Staines, VE3ZJ  
**Field Services Manager:** Jack Strangleman, VE3GV  
512 Pinetree Ave, London, ON N6H 3N1  
(519) 471-2301

**Awards Manager:** Garry Hammond, VE3XN  
5 McLaren Ave, Listowel, ON N4W 3K1  
(519) 291-4813

**Central Incoming QSL Bureau Manager:**  
Don Welling, VE1WF  
Box 51, Saint John, NB E2L 3X1

**Outgoing QSL Bureau Manager:**  
John Henderson, VE3HFT  
Box 56, Arva, ON N0M 1C0

**General Counsel:** Timothy S Ellam, VE6SH  
1600, 530 8 Avenue SW, Calgary, AB T2P 3S8  
(403) 234-7200

**Honorary Counsel:** B Robert Benson, QC,  
VE2VW

\*Voting member, CRRL Board of Directors

# Silent Keys

Conducted By Ray Staines, VE3ZJ

It is with deep regret that we record the passing of these amateurs:

VO1BY, James Moore, Carboneer, NF  
VO1EO, H G "Russ" Russel, Gander, NF  
VE1ALL, Harold Soderer, Oromocto, NB  
VE1BKM, J Stewart Hunter, Kensington, PE  
VE1FQ, J LeBreton "Brit" Fader, Halifax, NS  
VE1KC, Larry Dryden, Sackville, NB  
VE3DZR, Victor Hogarth, Brantford, ON  
VE3EMY, Murray Young, Scarborough, ON  
VE3LQO, L H "Dick" Mewett, Powasson, ON  
VE3OHN, Roy Norton, Bowmanville, ON  
VE3VY, George Fabi, Port Colbourne, ON  
VE5EH, Ernie Hedley, Saskatoon, SK  
VE6HK, Paul Liptak, Lethbridge, AB  
VE7FAA, Dennis Carter, Victoria, BC

**Note:** Silent Key reports sent to *QST Canada* must include name, address and callsign of the reporter. To avoid unfortunate errors, reports are confirmed only through acknowledgement from the family of the deceased. Thus, those who report a Silent Key may not receive an acknowledgement from *QST Canada*. ■



# Fessenden Plaque Unveiled

Remembering the man who gave us phone...

By Keith Baker, VE2XL  
133 Jasper Rd  
Beaconsfield, PQ H9W 5R7

**J**une 3, 1990: Brome County Historical Museum and Archives, Knowlton, Quebec. Several Montreal amateurs from the West Island and Montreal Amateur Radio clubs travelled to Knowlton, Quebec, birthplace of Reginald Aubrey Fessenden, to attend ceremonies and view the unveiling of a plaque honouring Reginald Aubrey Fessenden and commemorating the 90th Anniversary of the first transmission of voice by radio on December 23, 1900. Among other guests: Amateur Radio enthusiasts from Ontario and the US, shortwave listeners including members of the Canadian International DX Club and radio historians.

On the day of the unveiling, members of West Island Amateur Radio Club operated special-event station CK2CWI from the Knowlton site, and Montreal Amateur Radio Club operated special-event station CK2ARC (Fessenden's first phone transmission used an arc transmitter) from the Ebert Museum of Communications and Radio in nearby Sutton, Quebec. Operators from Montreal Amateur Radio Club included Patricia, VE2UJE, Mike, VE2DUB, Chris, VE2POL, and Dave, VE2MPD. ■



On hand for the unveiling of the Fessenden plaque (l-r): Tom, VE3CYL, Jon, VE2SH, Benoit, VE2JBF, Mark, VE2HVW, Earl, VE2BWQ, and CRRL President Bruce, VE2QO.

## Reginald Aubrey Fessenden 1866 - 1932

### Inventor of Radio, Genius, Pioneer and Mathematician

Eldest son of Rev Elisha Fessenden, an Anglican minister in East Bolton, Brome County, Canada East (now Quebec), and Clementina Treeholme Fessenden, the journalist who founded Empire Day, Reginald was born on October 6, 1866 in Knowlton, Quebec. The family moved to Fergus, Ontario, in 1872, and Reginald attended school there. Even at a young age, he showed a remarkable aptitude for mathematics, language and music. He closely followed the inventions of Thomas Edison. This eventually led to a position in Edison's experimental laboratory, one of the finest in the world.

Following this appointment, Fessenden held a succession of positions in electrical science: generator supervision at Westinghouse and a teaching position at Purdue University. All the while, he continued with his private experiments to further his cherished ambition, the transmission of sound—specifically the transmission of speech as opposed to "dots and dashes"—without wires.

After many unsuccessful attempts, Fessenden was rewarded: he produced the first transmission of the human voice without wires. The actual message was, "One, two, three, four. Is it snowing where you are, Mr Thiessen? If it is, telegraph back and let me know." This first transmission of voice by electromagnetic waves took place on December 23, 1900, while Fessenden was employed by the United States Weather Bureau.

On Christmas Eve, 1906, Fessenden and his assistants presented the world's first radio broadcast. The transmission included a speech by Fessenden and a selection of music for Christmas: Fessenden played Handel's *Largo* on the violin.

Reginald Aubrey Fessenden was responsible for many other inventions and received awards too numerous to mention. He died in Bermuda on July 22, 1932. His work has been widely recognized in the United States, but until recently, very little has been known of his work in Canada. —From the program, *Fessenden Plaque Dedication*, 1990 June 03, Knowlton, Quebec ■



Above: Ken, VE2MUX demonstrates loop modulation. Put a one or two-turn loop of wire in the field of the tank circuit, connect it to a carbon mike, and you're in business. Below: the author operates one of the CK2CWI stations. Others were inside. (VE2XL photos).





# Restructuring is Here!

## Part 1: Some answers to your questions.

By Harry MacLean, VE3GRO  
Editor, QST Canada

**T**he best laid plans of mice and men sometimes go astray, but as we sit at our word processor in mid-September, all indications are that Restructuring of the Canadian Amateur Service will go ahead on October 01. A lot has been said about restructuring and a lot has been written. Still, misinformation abounds, and, as I found out at a meeting of our local radio club, many amateurs still aren't sure what the new deal will be. We hope that this article—written in question and answer format—will help clarify things.

**Q.** What are the names of the new amateur certificates?

**A.** There's only one certificate. It's called the Amateur Radio Operator's Certificate. But it comes in several versions—what DOC calls levels of qualification.

**Q.** How many levels of qualification are there? What are they called? What are the requirements for each?

**A.** There are four level of qualification. The Basic Qualification is the new point of entry for the Canadian Amateur Service. You can't operate until you have it, even if you've passed your code or Advanced theory test. The examination for the Basic Qualification consists of 100 multiple-choice questions. At least 25 of these are on Canadian and international radio regulations. The remainder are on radio theory—that is, technical matters—and on operating procedures. You can take up to three hours to complete this examination. To pass, you must obtain a mark of 60%.

The Morse Code (5 wpm) Qualification involves both sending and receiving. Each test is three-minutes long. Text is in plain language (not cipher) and may include letters, numerals, punctuation marks (comma, period, question mark, dash and fraction bar), Q-signals and emergency signals. On the receiving test, you will be allowed two minutes to look over your work and make corrections. Pass mark for both the sending and receiving tests is 100%, but DOC defines 100% as five errors or less. You can also obtain the Morse Code (5 wpm) Qualification by obtaining 60% or more (fewer than 45 errors) on the 12 wpm code tests.

The Morse Code (12 wpm) Qualification is like the 5 wpm qualification: same format, same pass mark of 100%, same definition of 100%. It's just faster.

The Advanced Qualification is consid-

ered the most difficult to obtain. The examination consists of 50 multiple-choice questions on advanced radio theory. There are no questions on regulations or operating procedures. You can take up to one and one-half hours to complete the Advanced examination. Pass mark is 60%.

**Q.** No more Certificates A, B C and D?

**A.** That's right. DOC rejected that nomenclature some time ago.

**Q.** What privileges do you get with each level of qualification?

**A.** The holder of the Amateur Radio Operator's Certificate with the Basic Qualification may operate on all amateur frequencies above 30 MHz using a maximum transmitter power of of 250 watts DC input, all classes of emission. He or she may build and operate all station equipment except "home-built transmitters".

The holder of the Morse Code (5 wpm) Qualification, provided he or she already holds the Basic Qualification, may, in addition, operate on all amateur frequencies below 4.0 MHz, using a maximum transmitter power of of 250 watts

Restructuring should make Amateur Radio attractive to many newcomers. Below, John Cummings, VE3KGL, introduces the hobby to a prospective amateur at this year's Field Day.



DC input, all classes of emission, no "home-built transmitters".

The holder of the Morse Code (12 wpm) Qualification, provided he or she also has the Basic Qualification, may operate on *all* amateur frequencies using a maximum transmitter power of 250 watts DC input, all classes of emission, no "home-built transmitters."

The holder of the Advanced Qualification, in addition to privileges granted by other qualifications he or she may have already obtained, may build and operate home-built transmitting equipment, use a maximum transmitter power of 1000 watts DC input, sponsor repeater, club, and remotely controlled fixed stations and their radio links.

**Q.** Do you have to take the examinations in any order?

**A.** No, but we repeat that you will not be able to operate unless you first obtain the Basic Qualification.

**Q.** I've heard that there's a fee for writing the various examinations.

**A.** DOC will charge \$5 for administering an examination for each level of qualification. DOC allows some schools, clubs and even individuals to administer examination on their behalf. When someone other than DOC administers an examinations, fees are usually waived.

**Q.** Could a candidate write examinations for all four levels of qualification at one sitting?

**A.** That would cost \$20 and the candidate would be exhausted at the end, but this would be allowed.

**Q.** I've heard that a holder of a Restricted Radio Operator's Certificate can trade in their certificate for an Amateur Radio Operator's Certificate with the Basic Qualification. Is this true?

**A.** No. But a person holding a Canadian Radiotelephone Operator's General Certificate (Aeronautical, Maritime or Land) may do this. This is reasonable because the Canadian Radiotelephone Operator's General Certificate involves passing a difficult technical examination.

**Q.** At present, I have an "old" Amateur certificate. How do I fit into the Restructured Amateur Service?

**A.** You are now deemed to have the equivalent of all four levels of qualification. You can operate on all bands with all modes (observing subband restrictions, of course), using maximum legal power.

**Q.** Will DOC be sending me a new certi-



ificate saying that legally I can do this?  
A. Not likely. They might send you a notice with your licence renewal next spring. But why wait for spring? Do it now. On October 1, plug in your mike and talk. It will be legal. Trust us

Q. Before October 1, I obtained my Advanced. How do I fit into the restructured Amateur Service?

A. Same as those who held only the "old" Amateur certificate. (Sorry, but DOC had nothing more to give, hi.)

Q. I passed some of the "old" DOC examinations before October 1. Will I get credit for this?

A. If you passed the "old" theory or regulations tests, you will get *no* credit. If you passed the "old" theory and regulations tests, you can go to DOC and apply for the new Amateur Radio Operator's Certificate with the Basic Qualification. If you passed *only* your 10 wpm code test, you will be given credit towards the Morse Code (5 wpm) Qualification. If you passed everything, you've qualified for the "old" Amateur certificate. We've already told you what will happen then, so we won't repeat it here.

Q. With restructuring, will the written tests be easier or harder than in the past?

A. Probably for the next year (our guess), the written tests will be based on DOC's current questions bank, keeping, of course, the syllabus for the Restructured Amateur Service firmly in mind. But the pass mark has been lowered from 70% to 60%, and we know that DOC is going to keep things on a more practical level than was the case in the past. So the written tests should be easier.

Q. Where do I get a syllabus for the Restructured Amateur Service?

A. The syllabus was released in July. It should be available at any regional or district office of DOC. Ask for RIC-24.

Q. I've heard that RIC-25, the Extracts from the Radio Regulations, is under review.

A. That's right. Until the new version comes out, use the old version, still available from DOC.

Next month, we'll take a close look at RIC-24 and the requirements for two new written examinations. ■

## Ham-Ads



Advertisements must pertain to Amateur Radio. For individuals or firms offering products or services for sale, the rate is \$0.50 a word. This is reduced to \$0.25 per word for those seeking to dispose of or acquire personal station equipment. Telephone numbers count as one word. No charge for postal codes. Unless specified, a Ham-Ad will appear in the next available issue of *QST Canada*. Send Ham-Ads to CRRIL, Box 7009, Station E, London, ON N5Y 4J9.

WANTED: Lamp: signalling, daylight, short-range or long range with stand. Also Heliograph A Mark 3, commonly known as Lucas Lamp. Hollis Button, 1025 W Parr Ave, Campbell, CA 95008, USA.

## Montreal Unveils Emergency Plan

The Montreal Urban Community (MUC) President Michel Hamelin recently unveiled MUC's emergency plan, outlining how 29 cities in the greater Montreal area will deal with a major disaster.

The plan specifies a "task force" made up of representatives of Hydro Quebec, Gas Metropolitan, Bell Canada, CNCP Telecommunications, Transport Canada, the railroads, the news media, fire departments, police departments, hospitals—and radio amateurs. In the plan, Réseau d'Urgence Civil Amateur (RUCA, in English known as the Radio Amateur Civil Emergency Service or RACES) was officially recognized as a *major intervening force* in time of emergency.

RUCA is made up of over 100 local amateurs. They are well equipped and well trained. MUC has identified five types of disasters where the amateurs might serve: (1) release of dangerous materials, major explosions resulting in air contamination, (2) contamination of drinking water, (3) an major power blackout, (4) an airplane crash in a heavily populated area, and (5) natural disasters like tornados and earthquakes.

Under the plan, an emergency alert can be declared by any one of the 29 mayors in the MUC. But the man responsible for declaring a general alters is Fernand Gagnon, Director of Emergency Measures. The procedure is simple. One member of the task force heads to one of three MUC emergency bunkers and assume command of the control centre. The control centre then alters the intervener—including the radio amateurs of RUCA.

Let's that hope disaster never strikes. But if it does, RUCA is ready. —Jean-Serge Labelle, VE2ED ■

## The next Generation of Towers from Trylon...

# TITAN<sup>TM</sup>

O W E R S

**Available in heights up to 96', the Titan is engineered to support even heavier, bulkier loads. At the top where the weather is at its worst, the Titan is even stronger than its predecessors. And at the bottom a newly designed base section gives the Titan more rugged stability than ever before.**



**TRYLON**

MANUFACTURING CO. LTD.  
P.O. BOX 186, 21 HOWARD AVE. ELMIRA, ONT. CANADA N3B 2Z4  
TEL (519) 689-5421 FAX (519) 689-8912

FOR FURTHER INFORMATION CONTACT:

### H. C. MacFarlane Electronics Ltd.

Harold MacFarlane, VE3BPM, R.R.2, Battersea, ON K0H 1H0  
Telephone (613) 353-2800, Fax (613) 353-1294

Open Monday to Saturday, 7:30 a.m. to 9 p.m. Closed Sundays

In business since 1958—your one-stop ham shop!  
Antenna systems installed within a radius of 150 km.  
Expertise freely given anywhere!

In VE1, VE3 & VE2 Land outside of the Montreal area.

For orders and pricing only please!

Call Toll Free: 1-800-363-0930

Technical inquiries and regular business call (514) 336-2423.

If you have a FAX, use (514) 336-5929 at any hour.



Store hours

Mon .....	closed
Tue-Thu .....	9-5
Fri .....	9-9
Sat .....	10-2



Notice

Hobbytronique is a factory authorized dealer for Icom, Kenwood, and many other companies. When you buy from us you buy with confidence that your purchase carries a full factory warranty!

**Super Special!**

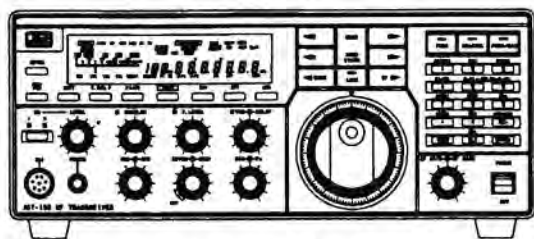

Japan Radio JST-135. Regular price \$2750, we have a very limited quantity at the special introductory price of \$1999.



**Kenwood TS950SD**

Ordering Information

Shipping charges for prepaid orders are 2% of order, minimum \$4, except for large or heavy items. For C.O.D. orders, shipping charges are 3%, minimum \$7.  
*Quebec residents please add 9% sales tax.*



Feature Highlights!

- 150 watt continuous output.
- Built-in antenna tuner with new fast-tune circuit.
- Three digital peak-reading meters with peak-hold.
- 99 memories which store frequency, mode, filter and tone info.
- New digital signal-processing unit.
- Direct frequency input with improved calculator format keypad.
- Independent selection of filter bandwidths at both I.F. frequencies.
- Dual receive capability.
- High performance S.S.B. filter options.
- Electronic keyer.
- Plus all the features of the popular TS940!

TS950S. The base model includes the electronic keyer, antenna tuner and power supply. \$CALL  
TS950SD. The Digital model adds the digital signal processor, CW filters and high performance SSB filter to the 455KHz I.F. as standard equipment. \$CALL  
TS940SAT. The popular TS940 will continue to be available for the foreseeable future. An excellent radio at an affordable price. \$3099.

8104A Trans-Canada Hwy, St. Laurent, Qué. H4S 1M5

**Hobbytronique Inc.**



# The Easy Patch

Junk box parts + a little ingenuity = a useful station accessory.

By Frank Burke, VO1BZ  
Box 5612, EEPO  
St John's, NF A1C 5W8

Recently I wanted to run a phone patch on the HF bands, but I had a small problem: no patch! Digging into my files of articles clipped from various Amateur Radio publications inspired me to try my hand at constructing one. The patch I built was simple, easy-to-build, and very inexpensive. I offer this circuit to those who, like me, need a basic phone patch in a hurry.

## Circuit Description

This unit brings together the telephone line, the audio from the rig, and the rig's microphone line for switching and coupling. When the patch is not in use, the microphone works normally.

The circuit is as follows: The telephone signal is filtered and decoupled and then switched, either to transformer T1 or T2, or out of the circuit, all by switch S1. T1 feeds the audio from the rig to the telephone line so the caller can hear what is coming over the air. T2 couples the caller's voice to the microphone input of the rig, by way of the level control R1, and switch S2. This second switch selects either normal microphone operation, or throws the rig into transmit, selecting the telephone line as the input at the same time.

## Construction

Construction is simple and straightforward. Two Hammond 140-series coupling transformers and a pair of DPDT toggle switches (one of these, S1, has a centre-off position) make up the heart of this unit. The transformers are ones I happened to have easy access to, but others with a reasonably high impedance (over 1 k $\Omega$ ) will work. In fact, none of the component values are critical, so try whatever

you have on hand. All parts were installed in a small metal project box.

Jacks for all the cables are installed at the back of the box, allowing quick connection or removal as required. You need one for each of the following: the rig's audio output, the speaker and the telephone line. You need two for the microphone. Extra jacks allow connection of a tape recorder and other audio equipment.

## Testing and Operation

Mounting the toggle switches

close together makes it easy to operate both switches with one finger. This arrangement is versatile, allowing complete control of the station at all times. On hearing each party say "Over", you manually switch between receive and transmit. Not state-of-the-art, perhaps, but it works. When the patch is not in use, S1 stays in the centre-off position and S2 reconnects the station microphone.

Several on-the-air tests with VO1OU, VO1BD and VO1WP confirm that this unit operates beautifully. As a

bonus, in addition to conventional phone patching, this unit has other uses. It can be used to interface a telephone line with a public address (PA) system in an auditorium, meeting hall or church. Those not able to attend could listen by telephone if audio from the PA system were fed into the patch. Or a speaker, not able to appear in person, could address the group. You can probably think of other uses.

Now, dig into the junk box and build an Easy Patch for your station! You'll be glad you did! ■

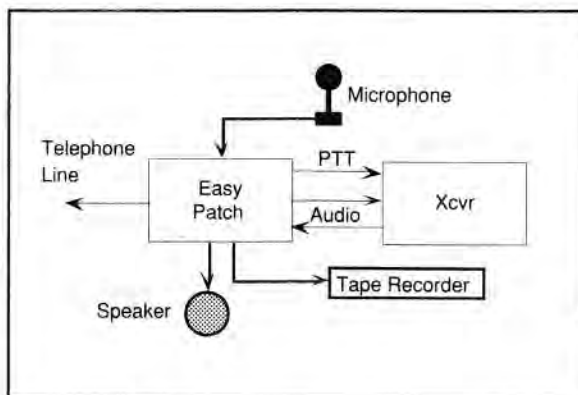
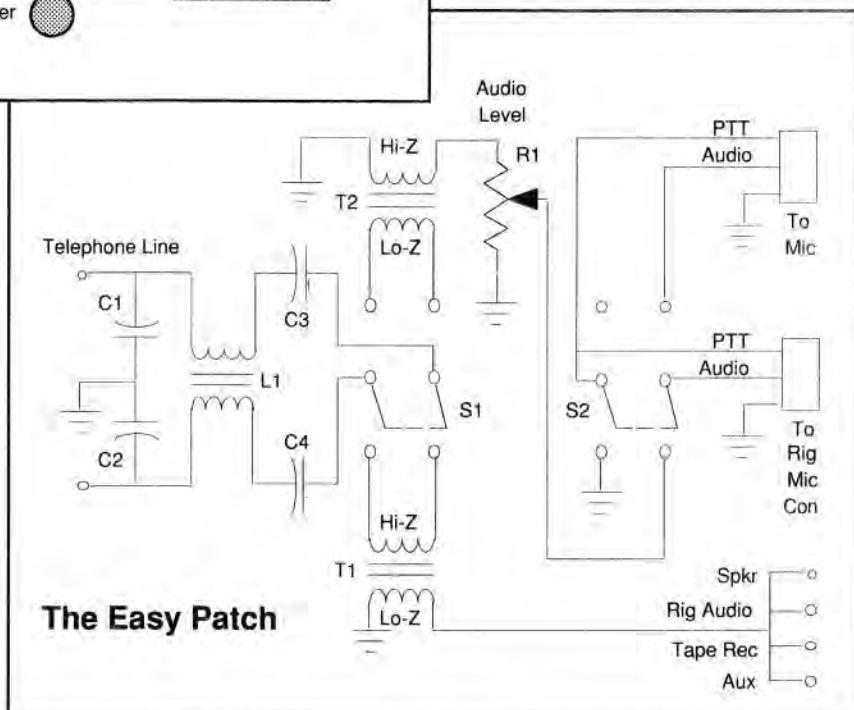

Fig 1 (left)—Basic concept of the Easy Patch.

Fig 2 (below)—Component values are not critical. Some typical values:

C1, C2—0.001  $\mu$ fd @ 100 WV  
C3, C4—0.05  $\mu$ fd @ 100 WV  
L1—RF choke: double winding, 15–20 turns on a ferrite core  
R1—50 k $\Omega$  potentiometer  
S1, S2, T1, T2—see text



The Easy Patch



# Com-West Price Spectacular!

## Brand New Kenwood TH-215AT Handhelds

for as little as  
**\$303.60** each\*



Now is your chance to own a new Kenwood VHF Handheld at a super special limited offer while stocks last!

- If you buy one TH-215AT you pay only \$399 (regular \$529)
- If you buy two TH-215ATs you pay only \$699 for both (\$349.50 each)

Or

- \*If you get a group together and buy five TH-215ATs, we'll give you the lot for only \$1549! Take advantage of our 2% cash discount (not valid with credit card orders) by enclosing a money order or certified cheque with your order, and the total price drops to \$1518.00, or \$303.60 each!

### Features

- Wide receiver frequency coverage - 141 to 163 MHz
- Five watts output (with optional PB-1 battery pack)
- Multiple scan modes
- Large, easy-to-read LCD display
- Selectable CTCSS Tone Encoder built-in
- 10 memories
- Intelligent 2-Way Battery Saver Circuit
- Includes PB-2 Battery and Wall Charger

Also available: TH-415AT  
UHF Handheld for  
\$429 - very limited  
stock!

### Price

#### Breakthrough

Now Only \$299.95

A limited supply of Uniden 2600  
10 meter rigs with RIT, ON/OFF,  
Repeater splits, sub audible tone,  
mike and power cable.

Cash price  
\$299.95  
incl. shipping



### Optional Accessories

- |   |       |
|---|-------|
| • BC-7 Rapid Charger                    | \$179 |
| • BC-8 Compact Charger                  | \$69  |
| • PB-1 Battery Pack (12VDC 800mAh)      | \$99  |
| • PB-3 Battery Pack (7.2VDC 800mAh)     | \$76  |
| • PB-4 Battery Pack (7.2VDC 1600mAh)    | \$109 |
| • BT-5 Battery Case (AA size batteries) | \$29  |
| • PG-3E Filtered Cigar Lighter Cord     | \$32  |
| • SMC-31 Speaker Microphone             | \$79  |
| • SC-12 Soft Case (for PB-2,3)          | \$29  |
| • SC-13 Soft Case (for PB1,4)           | \$29  |

Terms: Cheque or Credit Card only. Surface Shipping included to most Canadian points.

**COM-  
WEST**  
Radio Systems Ltd.

(604) 321-1833

Fax: (604) 321-6560

8179 Main Street Vancouver, B.C. V5X 3L2

#### Store Hours:

Monday - Thursday  
Friday  
Saturday

(PST)

9:00 am to 6:00 pm  
9:00 am to 6:00 pm  
9:00 am to 4:00 pm



## CRRL Board of Directors Elections

By cutoff date, August 17, valid nominations were received for incumbents David Fancy, VE7EWI (Pacific Region), Ken Oelke, VE6AFO (Alberta Region), David Snyder, VE4XN (Midwest Region), Ray Perrin, VE3FN (Ontario North Region), and Carl Anderson, VE1UU (Atlantic Region). With no opposing nominations, those who were nominated were declared elected. No nominations were received from the CRRL Ontario South and CRRL Quebec regions.

To all CRRL members in the Ontario South Region (L, M and N postal code areas) and in the Quebec Region, you are again solicited for nominations for CRRL Regional Directors to serve during the next two-year term of office that begins on 1991 January 01.

Under CRRL By-laws, candidates for Regional Director must (1) reside in the Region they intend to represent, (2) have been a CRRL Full member for a continuous term of four years at time of nomination, (3) have been a licensed Canadian amateur throughout those years, and (4) be at least 21 years of age. Additional information appears in the CRRL By-laws, available on request.

To be valid, a nominating petition must carry the signatures of ten or more CRRL Full members residing in the Region concerned. It is advisable to have more than ten signatures. Photocopied signatures are not acceptable. Signatures must be on the petition.

Petition forms, EDC-1 are available from CRRL Headquarters, but are not required. The following is acceptable:

..... (place and date)

CRRL Elections Committee  
Box 7009, Station E  
London, ON N5Y 4J9

We, the undersigned CRRL Full members residing in the ..... Region hereby nominate ..... (name and callsign) as candidate for Director of this Region for the next two-year term of office.

..... (signatures and callsigns), .....  
(addresses including postal codes)

Nominating petitions will be received at the CRRL Headquarters office until 1200 EST, 1990 December 14. Eligibility of candidates will be determined shortly after that. If only one eligible candidate is nominated in a Region, that candidate will be declared elected. If more than one candidate is nominated in a Region, a balloted election will take place. On or just before 1991 February 01, the CRRL Elections Committee will mail ballots to every person who, on 1991 January 01, was a CRRL Full member in the Regions where the elections are taking place. Ballots will

carry a copy of the CRRL By-laws governing the election, and biographical material supplied the candidates, each up to 300 words in length. Marked ballots will be received at CRRL Headquarters until 1991 March 16, and will be counted shortly after that in the manner prescribed in the CRRL By-laws. Results will be announced in the *CRRL News* bulletins and in *QST Canada*.

Over the next two years, CRRL deserves the best leadership possible. You are urged to take the initiative and file a nominating petition immediately. —W W Loucks, VE3AR, *CRRL Secretary*

### THE GST

□ Many amateurs are still not aware that, on 1991 January 01, the federal government's new Goods and Services Tax (GST) will be applied to all magazines, including Amateur Radio magazines published in the US and Canada. Last May, to minimize the impact on CRRL members, the CRRL Board separated CRRL membership from subscription costs for *QST* and *QST Canada*. This means that CRRL members will have to pay tax only on the magazines they receive, and not on the combined cost of magazines and membership. Of course, CRRL members can avoid the tax completely by renewing now. There's a coupon on page 20.

### RESTRUCTURING: IT'S HERE!

At press time, all indications were that Restructuring of the Canadian Amateur Service would take place on schedule: 1990 October 1. RIC-24, the syllabus for the Restructured Amateur Service is available from DOC offices across Canada. A word on DOC's new examinations. Initially, DOC will rely on its present questions bank, of course keeping the new syllabus firmly in mind. New questions, supplied by CRRL and CARF, are expected to be added next year.

### GETTING READY FOR WARC

□ For those who missed the note in last month's column, ITU, the International Telecommunications Union, has released its agenda for WARC-92. As expected, WARC-92 is not a general WARC. Instead, it is being called to address some specific issues that specialized WARCs, held throughout the 1980s, were unable to deal with. Officially, Amateur Radio is *not* on the agenda. However, Amateur Radio is threatened by several agenda items, particularly "the possible extension of the frequency spectrum allocated exclusively to HF broadcasting". Broadcasters will likely be looking for frequen-

cies in and around our 40-metre band, and several administrations are looking for frequencies for a new mobile-satellite service, possibly in and around our 2-metre band. One interesting development: it now appears that WARC-92 will be followed by a second conference, a WARC-93. IARU, the International Amateur Radio Union, is monitoring all developments and making preparations to defend our frequencies at both these conferences.

□ A reminder about Canada's Defence of Amateur Radio Fund (DARF), set up to help IARU defend our amateur frequencies at WARC-92 and WARC-93. Many amateurs have been generous and there is now over \$7000 in this fund. Even so, much more money is needed. Please send your cheque to DARF, c/o Tim Ellam, VE6SH, 107 Strathearn Rise SW, Calgary, AB T3H 1R5.

### 40-METRE RUMOURS

□ According to *Westlink Report* and the Radio Nederlands "Media Network" program, "negotiators for amateur interests" have reached an agreement on a possible realignment of the 40-metre band, to 6.95-7.25 MHz, AMATEUR exclusive on a worldwide basis. If this were to happen, shortwave broadcasters would move up to 7.25-7.75 MHz, also exclusive on a worldwide basis. Identity of the "negotiators" was not revealed, nor was a time frame suggested for a possible change. At present, much of the 40-metre amateur band is shared with broadcasters.

### DXCC USER FEE

□ On October 1, ARRL will initiate a user fee for DXCC. After October 1, every first-time applicant for DXCC will be charged US \$10. ARRL and CRRL members will be allowed, free-of-charge, one submission per calendar year. This submission may include any number of QSLs, any number of DXCC awards and any combination of new and endorsement applications. ARRL and CRRL members who submit more than once per calendar year will be charged US \$10 for each submission after the first. This fee structure is being implemented to encourage DXCC participants to make fewer submissions for DXCC, and to provide better service for those who do submit.

### VE7 QSL BUREAU UPDATE

Many thanks to Alex Ivsic, VE7CNE, for serving as Manager of the CRRL VE7 Incoming QSL Bureau for the past several years. New bureau manager is Dennis Livesay, VE7DK. New bureau address is 8309 112 St, Delta, BC V4C 4W7. ■



# KENWOOD

## Kenwood—Pacesetter in Amateur Radio

Kenwood—producing the finest Amateur Radio products for over four decades—introduces you to our world of affordable, high quality, high performance products for today's active Radio Amateur. From HF to VHF, from base to mobile to HT, there's surely a Kenwood radio that will fit your needs and budget.

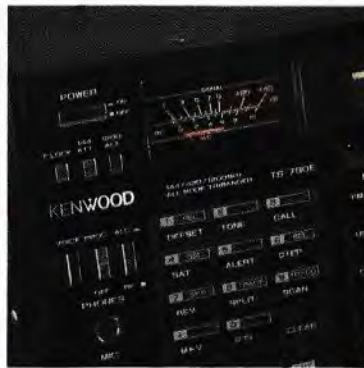

KENWOOD ELECTRONICS CANADA INC.  
P.O. BOX 1075, 959 Gana Court, Mississauga, Ontario, Canada L4T 4C2



**DSP**  
Digital Signal Processing

Digital Signal Processing

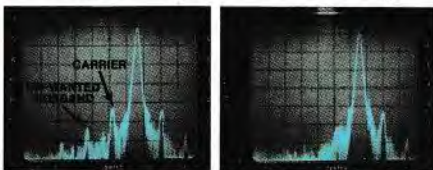

Without DSP

With DSP

**TS-950SD**  
"DX-clusive" HF Transceiver



The new TS-950SD is the first Amateur Radio transceiver to utilize Digital Signal Processing (DSP), a high voltage final amplifier, dual fluorescent tube digital display and digital meter with a peak-hold function.

• **Digital Signal Processor.** DSP is a state-of-the-art technique that maximizes your transmitted RF energy. Your signal stands out because it is much more pure than your competition! You can even tailor your transmitted CW or voice signal waveshape!

• **Dual Frequency Receive Function.** The TS-950SD can receive two frequencies simultaneously. The sub-receiver has independent controls for frequency step size, noise blanker, and AF gain and its own digital display!

• **New! Digital AF filter.** Synchronized with SSB IF slope tuning, the digital AF filter provides sharp characteristics for optimum filter response.

• **New high voltage final amplifier.** 50V power transistors are used in the 150W final section, resulting in minimum distortion and higher efficiency. Full-power key-down time exceeds one hour.

• **New! Built-in microprocessor controlled automatic antenna tuner.** The new antenna tuner is faster and you can store the settings in memory! (Manual override is also possible.)

**Optional Accessories**

- VS-2 Voice synthesizer
- SP-950 External speaker w/AF filter
- SM-230 Sta-

- tion monitor w/pan display
- SW-2100 SWR/power meter
- TL-922A Linear amplifier (not for QSK)

Transmit  
the  
ultimate  
signal.

• **Outstanding general coverage receiver performance and sensitivity.** Kenwood's Dyna-Mix™ high sensitivity direct mixing system provides incredible performance from 100 kHz to 30 MHz. The Intermodulation dynamic range is 105 dB.

• **Multi-Drive Band Pass Filter (BPF) circuitry.** Fifteen band pass filters are available in the front end to enhance performance.

• **High performance IF filters built-in.** Select various filter combinations from the front panel. For CW: 250 and 500 Hz, 2.4 kHz for SSB, and 6 kHz for AM. Filter selections can be stored in memory!

• **Kenwood interference reduction circuits.** SSB Slope Tuning, CW VBT (Variable Bandwidth Tuning), CW AF tune, IF notch filter, dual-mode noise blanker with level control, 4-step RF attenuator (10, 20, or 30 dB), switchable AGC circuit, and all-mode squelch.

• **Built-in TCXO for highest stability.**

• **Built-in electronic keyer circuit.**

• **100 memory channels.** Store independent transmit and receive frequencies, mode, filter data, auto-tuner data and CTCSS frequency.

• **Digital bar meter.**

**Additional Features:** • Built-in interface for computer control • Programmable tone encoder • Optional VS-2 voice synthesizer • Built-in heavy duty AC power supply and speaker • Adjustable VFO tuning torque • Multiple scanning functions • MC-43S hand microphone supplied

KENWOOD U.S.A. CORPORATION  
COMMUNICATIONS & TEST EQUIPMENT GROUP  
P.O. BOX 22745, 2201 E. Dominguez Street  
Long Beach, CA 90801-5745  
KENWOOD ELECTRONICS CANADA INC.  
P.O. BOX 1075, 959 Gana Court  
Mississauga, Ontario, Canada L4T 4C2

**KENWOOD**

...pacesetter in Amateur Radio

Specifications, features and prices subject to change without notice or obligation. Complete service manuals are available for all Kenwood transceivers and most accessories.



# THE CRRL BOOKSHELF

## STUDY MATERIALS

	Non-Member	Member	Postage	Stock#	✓
Talk to the World	\$20.00	\$18.00	\$1.00	102	<input type="checkbox"/>
Beginner's Code Tape	(OT) 12.50	11.75	1.00	201	<input type="checkbox"/>
5-10 WPM Code Tape	(OT) 12.50	11.75	1.00	2027	<input type="checkbox"/>
10-15 WPM Code Tape	(OT) 12.50	11.75	1.00	2035	<input type="checkbox"/>
First Steps in Radio, W1FB	8.00	7.25	.75	470	<input type="checkbox"/>
Premier pas en radio, W1FB	8.00	7.25	.75	F900	<input type="checkbox"/>
Operating an Amateur Radio Station	1.25	1.25	1.25	300	<input type="checkbox"/>
Help for New Hams	12.50	11.25	1.00	475	<input type="checkbox"/>

## CRRL INSIGNIA

Lapel Pins	(OT) 3.00	3.00	.75	130	<input type="checkbox"/>
Large Cloth Diamond (5")	(OT) 3.00	3.00	.75	141	<input type="checkbox"/>
Small Cloth Diamond (3")	(OT) 2.00	2.00	.75	151	<input type="checkbox"/>
ARES Circular Patch (4")	(OT) 4.00	4.00	.75	161	<input type="checkbox"/>
Set of 3 CRRL Logo Decals	(OT) 1.00	1.00	.75	180	<input type="checkbox"/>

## OTHER

Fifty Years of ARRL	5.75	5.25	.75	460	<input type="checkbox"/>
From Spark to Space	25.00	22.50	1.00	465	<input type="checkbox"/>
Night Signals (adventure)	6.25	5.75	.75	856	<input type="checkbox"/>
Tompkins Adventures (6 books)	30.00	27.00	1.50	855	<input type="checkbox"/>
200 Metres and Down	10.00	9.00	.75	560	<input type="checkbox"/>

## OPERATING AIDS

1990 Repeater Directory	(OT) 7.50	6.75	1.50	194	<input type="checkbox"/>
Log Book (pack of 3)	(OT) 10.00	9.00	2.00	122	<input type="checkbox"/>
Super Log Book (pack of 3)	(OT) 17.00	15.00	2.00	126	<input type="checkbox"/>
Radiogram Forms	(OT) 2.50	2.25	1.50	171	<input type="checkbox"/>
Grid Locator for North America	(OT) 2.00	1.50	1.00	800	<input type="checkbox"/>
DXCC Countries List	(OT) 2.00	1.50	1.50	812	<input type="checkbox"/>
1990 Net Directory	(OT) 2.00	1.50	2.00	824	<input type="checkbox"/>
ARRL World Map	(OT) 14.00	12.50	2.50	840	<input type="checkbox"/>
Callbook <i>folded</i> Map of the World	(OT) 6.50	6.00	1.00	RA10F	<input type="checkbox"/>
Callbook Prefix Map of the World	(OT) 8.50	7.75	*3.50	RA10	<input type="checkbox"/>
Callbook Prefix Map of N America	(OT) 8.50	7.75	*3.50	RA11	<input type="checkbox"/>
Callbook Great Circle Map of World	(OT) 8.50	7.75	*3.50	RA12	<input type="checkbox"/>

\*These maps can be shipped together. Add \$3.50 postage only once per order.

## PACKET AND COMPUTERS

Gateway to Packet Radio, 2nd Edition	16.00	14.50	.75	901	<input type="checkbox"/>
--------------------------------------	-------	-------	-----	-----	--------------------------

**IMPORTANT!** In the past, books were **NOT** taxed. Next year they will be taxed under the GST. You face paying 7% more for books in the future. **IF YOU ARE THINKING OF ADDING TO YOUR TECHNICAL LIBRARY**, we suggest that you do so this year. **PLEASE ORDER EARLY.** We must send the books to you this year to avoid having to charge you the tax, and we could be overwhelmed if everyone waits until December to order.

## ANTENNA BOOKS

	Non-Member	Member	Postage	Stock#	✓
ARRL Antenna Book	\$22.50	\$20.50	\$1.50	411	<input type="checkbox"/>
RSGB HF Antennas for All Locations	19.00	17.00	1.00	330	<input type="checkbox"/>
Antenna Compendium #1	12.50	11.75	1.00	420	<input type="checkbox"/>
Antenna Compendium #2	15.00	13.50	1.00	421	<input type="checkbox"/>
Antenna Notebook, W1FB	12.50	11.25	.75	405	<input type="checkbox"/>
Novice Antenna Notebook, W1FB	10.75	9.75	.75	425	<input type="checkbox"/>
Antenna Impedance Matching	19.00	17.00	1.00	450	<input type="checkbox"/>
Yagi Antenna Design	19.00	17.00	1.00	630	<input type="checkbox"/>
All About Vertical Antennas	13.75	12.50	1.00	RP120	<input type="checkbox"/>
Simple, Low-Cost Wire Antennas	15.00	13.50	1.00	RP140	<input type="checkbox"/>
Transmission Line Transformers	12.50	11.25	.75	880	<input type="checkbox"/>

## OPERATING

Operating Manual	19.00	17.00	1.50	522	<input type="checkbox"/>
Complete DXer, 2nd edition	16.00	14.50	.75	441	<input type="checkbox"/>
Low Band DX	12.00	11.00	.75	890	<input type="checkbox"/>
Low Band DX Software (available for many computers; send SASE for prices)					

## TECHNICAL

ARRL Electronics Data Book	15.00	13.50	.75	516	<input type="checkbox"/>
Radio Frequency Interference	6.25	5.75	.75	532	<input type="checkbox"/>
Solid State Design	15.00	13.50	1.00	551	<input type="checkbox"/>
Hints and Kinks, 12th edition	10.00	9.00	.75	512	<input type="checkbox"/>
QRP Notebook, W1FB	8.00	7.25	.75	590	<input type="checkbox"/>
Transmitter Hunting	24.00	21.50	1.00	390	<input type="checkbox"/>

## VHF-UHF

All About VHF Amateur Radio	15.00	13.50	1.00	RP130	<input type="checkbox"/>
Satellite Anthology	10.00	9.00	.75	700	<input type="checkbox"/>
Satellite Experimenter's Handbook	12.50	11.25	.75	540	<input type="checkbox"/>
Space Almanac	27.50	25.00	1.50	705	<input type="checkbox"/>
Weather Satellite Handbook	25.00	22.50	1.00	695	<input type="checkbox"/>
Microwave Handbook, Vol. 1 (RSGB)	44.00	40.00	1.00	345	<input type="checkbox"/>
UHF/Microwave Experimenters	25.00	22.50	1.00	365	<input type="checkbox"/>

## CRRL Publishing, Inc., Box 7009, Station E, London, ON N5Y 4J9

**How to order:** Please check (✓) the box at the end of the line for each item you want. Add costs and the amounts shown for postage. Enclose your personal cheque or money order for the total amount of the order. **Ontario residents: Add sales tax on total of costs and postage for all items marked (OT).** Thank you.

Name: \_\_\_\_\_ Call: \_\_\_\_\_

CRRL Member?

Address: \_\_\_\_\_

Yes  No

\_\_\_\_\_

I enclose \$ \_\_\_\_\_

\_\_\_\_\_ Postal Code: \_\_\_\_\_

(Signature)



## The CRRL Field Organization Forum

### SECTION MANAGER ELECTION NOTICE

To all CRRL members in the Ontario Section: You are hereby resolicited for nominating petitions pursuant to an election for Section Manager. A petition, to be valid, must carry the signatures of five or more CRRL Full members residing in the Ontario Section. It is advisable to have more than five signatures. Photocopied signatures are not acceptable and signatures must be on the petition. Petition forms, FSD-129-C, are available from CRRL Headquarters in London, Ontario, but are not required. The following form is acceptable:

..... (place and date)

CRRL Field Services Manager  
Box 7009, Station E  
London, Ontario N5Y 4J9

We, the undersigned CRRL Full members residing in the Ontario Section, hereby nominate ..... (name and call sign) as Section Manager for this Section for the next term of office: ..... (signatures and call signs) ..... (addresses with postal codes).

A Section Manager must be a resident of his or her Section and a licensed radio amateur holding a Canadian Advanced Amateur Certificate or equivalent, and have been a CRRL Full member for a continuous term of two years at time of nomination.

Petitions will be received at the CRRL Headquarters office until 1600 EDT 1990 December 07. If only one valid petition is received, the person nominated will be declared elected. If more than one valid petition is received, a balloted election will take place. Ballots will be mailed from CRRL Headquarters on 1991 January 02. Returns will be counted after 1990 February 20. A Section Manager elected as a result of these procedures will serve for a two-year term of office beginning on 1991 April 01.

You are urged to take the initiative and file a nominating petition immediately.  
—Jack Strangleman, VE3GV, Field Services Manager

### REPORTS FOR JULY 1990

**Alberta:** SM/STM/DEC: Bill Gillespie, VE6ABC; ASM: VE6AMM; SEC/TC: VE6AFO; OO: VE6TY. The Glacier-Waterton Hamfest is now over. From all reports, it was well attended and had good weather. Band conditions on 80 metres are still poor. QNI is low because of this. Thoughts are now turning to fall Amateur Radio classes and the Restructured Amateur Service. Northern Alberta Amateur Radio Club has been involved with the Alberta Motor Association in providing reports of highway traffic on all major roads in and out of Edmonton on all long week-

**Reports invited:** CRRL Section Managers (SMs) and their Section-level assistants coordinate traffic handling, emergency communications and bulletin service across Canada. Your SM (name and address appears on page 2 of this *QST Canada*) welcomes reports of individual and club activities for publication in this column. Activities do not have to be related to the CRRL Field Organization or to CRRL.

ends. This is called the "Bring 'em Back Alive" program. About ten operators are used on the Friday and Monday afternoons.

**British Columbia:** SM/SEC: Ernie Savage, VE7FB. Net Manager Ferdi, VE7EJU, has been house moving this month. As a result, we have no month-end report! Worst yet for June QTCs, which are down about 100. British Columbia Public Service Net Manager Ford, VE7DDF, reports high: 185, low: 63 and total: 3978. His check-ins were also down, by 90. Holidays were probably part of the reason. Both nets found that band were conditions poor. Gordon, VE7TR, suffered a stroke while visiting the prairies. He is back home now, taking it easy. George, VE7DJ, suffered a minor stroke and is at home recovering. Al, VE7AJJ, is on the sick list, and Joe, VE7ESA, had a change of heart pacer and also suffered a mild stroke. Surrey ARC will be at the Pacific National Exhibition with their special call, CY7PNE.

**Manitoba:** SM: Bill Crooks, VE4JR; ASM: VE4IX; SEC: VE4TM; ATC: VE4ADP; NMs: VE4LB, VE4IX, VE4TE. I wish to thank you for electing me your Section Manager. This is my first try at a monthly report for the Section, so please bear with me. Remember, the more information I get, the more I can put into this column. Winnipeg Seniors ARC is now in its eighth year. Members monitor the Trans-Canada Net and local repeaters. They also handle third-party traffic in the CFARS nets. Training classes will start up in the fall for prospective senior amateurs. Both Winnipeg Seniors ARC and Winnipeg ARC provided radio communications for the Manitoba Marathon. An active station was set up at the Museum of Man and Nature, and both clubs provided operators for the display. A joint effort between Winnipeg and Portage amateurs provided communications for the Multiple Sclerosis Bike-a-thon. Many thanks for helping with this worthwhile cause. Another joint effort, this time between the Brandon and Winnipeg clubs, will provide contacts for the 1990 Canadian Trail Riding Championships on Labour Day weekend. The trials are being held south of Brandon. Your SM attended the International Peace Garden Hamfest held on July 11–15. A record number were in attendance. It was nice to renew old acquaintances and make new friends, and especially nice to be able to put a face to a name or call. 73.

**Maritimes-Newfoundland:** Acting SM: Carl Anderson, VE1UJ; STM: Mel Lever, VE1VX; BM: Brent Taylor, VE1JH. Traffic Manager Mel Lever, VE1VX, advises that new Atlantic Provinces Net (APN) Manager is Ken Walker, VE1YS (formerly VE1ADJ) of Ellershouse, Nova Scotia. APN is the National Traffic System (NTS) net for the Maritimes and Newfoundland. It meets nightly on 3654 kHz at 2000 AST/ADT. New participants are always welcome. I received a Field Day message from Fredericton ARC in addition to those from Halifax and Greenwood ARCs, mentioned in last month's column. Greenwood ARC will hold its Second Annual Ham Fleamarket at Gillwell Hall, Greenwood, Nova Scotia, 0900–1500 on Saturday, October 20. Route to the fleamarket will be well

marked for cars arriving via Highway 101. Talk-in will be available on the VE1WN repeater, 146.67 MHz (–), and on 146.52 MHz simplex. A new Amateur Radio club is being formed in the Parrsboro, Nova Scotia, area. For information, contact club secretary Elaine Wheaton, VE1CFX, 3 Queen St, Parrsboro, NS B0M 1S0. Amateur Radio clubs conducting fall radio classes should consider using CRRL's new Canadian Amateur Radio licensing manual: *Talk to the World*. Contact CRRL Headquarters for details on availability and quantity price discounts.

**Ontario:** SM: Larry Thivierge, VE3GT; BM: VE3GSA; SEC: VE3GV; STM: VE3CYR; TC: VE3EGO. I would like to take this opportunity to thank all the hard-working bulletin editors from the following clubs who regularly send me a copy of their bulletins: Algoma ARC, Kitchener-Waterloo ARC, Lakehead ARC, London ARC, Niagara Peninsula ARC, North Shore ARC, Ottawa ARC, Peterborough ARC, Peel ARC, QCWA Chapter 73, Scarborough ARC, South Pickering ARC, Sudbury ARC, Toronto FM Communications Society (TFMCS), Windsor Sun Parlour ARC and Windsor ARC. With the help of the bulletin editors and the help of individual amateurs who provide me with news of interesting happenings and events in this Section, this column would not be possible. My nod for best bulletin would have to go to Sudbury ARC, editor VE3OTH. Most improved bulletin would be TFMCS, editor VE3PXS. Congratulations to VE7CC who won the Most Accurate CW Operator award in the recent World Radiosport Team Championship. Twenty-two teams from 15 countries vied for gold, silver and bronze medals. The event was described as a "resounding success". Algoma ARC, under the direction of VE3KOF, provided the communications for the Sault Ste-Marie community parade. Participants included VE3GF, VE3GWN, VE3JIY, VE3PHB, VE3OTL, VE3RET, VE3TNL and VE3UFO. New amateurs in the Section are Dave, VE3ADW, and Jeff, VE3FSH. I had an enjoyable visit to the East Coast this summer. I enjoyed working the Fredericton and Charlottetown repeaters. Nice to talk with VY2KK and VE3FGT on VE1H.

**Quebec:** SM: Harold Moreau, VE2BP; STM: VE2EDO; SEC: VE2LYC; BM: VE2ALE. VE3GOP has been appointed OBS. Garnett operates mostly packet on 2 metres. Léon, VE2VL, a cesser ces activities sur les bandes HF, mais à l'occasion est sur VHF. Le Réseau de VE2TA a repris depuis le 3 septembre ainsi que le marché aux puces du mercredi soir.

**Saskatchewan:** SM: Bruce Rattray, VE5RC. Ernie Hedley, VE5EH, became a Silent Key on July 13. Saskatchewan CRRL officials held a mid-summer meeting in Regina on August 4. Present lineup is Bulletin Manager: VE5GHC, Section Emergency Coordinator: VE5FY, Section Traffic Manager: VE5ELJ, and Section Manager: VE5RC. Welcome to Joan, VE5JML, who is Assistant Section Manager. Bill, VE5EE, has been busy climbing towers, this time up to 230 feet to install the 440 MHz-antenna for linking Regina with Saskatoon. Another fine time, with



## Operation Fox Whiskey

One of the rarest DXCC countries in the Pacific is FW—Wallis and Horn Islands (Futuna and Alofi). There have been few DXpeditions to these islands. Extremely high travel and living costs usually keep amateurs away.

One day in February, 1990, I was invited to lunch at the home of the famous Pacific Islands artist, Nicolai Mitchoutouchkine. There, I met Sosefo Hansen Wallenstein who was vacationing in Port Villa. We quickly became friends. He invited me to stay and transmit from his home in Wallis Island. This accelerated my decision to go there, for I realized that Futuna and Alofi were still virgin islands for IOTA (Islands on the Air), and I wanted to activate them.

At Wallis Airport, Sosefo was waiting for me with a traditional ula, a necklace of hibiscus flowers. Then came licensing formalities. I received a temporary permit to transmit under the callsign FW/YJ8M.

It took me several hours to set up my station in Sosefo's house, and to erect the antenna. I put my R5 on a pole 1.5 metres high. On 1990 March 22 at 0800 UTC, I started transmitting on 15 metres. My first contact was with a friend from Vila, Rod, YJ8RN. Later on, I worked many stations in Japan, Europe, Asia and South America.

Next day from 0000 to 0300 on 28 MHz, I worked mainly US and Canadian stations. Weather was bad and I did not have good propagation. I had the feeling that my antenna was not doing a proper job. I checked the SWR. It was over 3:1. I found that the antenna's compact traps were not in the proper place. I fixed the antenna and followed Sosefo's advice to put the antenna in a breadfruit tree. We cut off the top the tree and attached the antenna. Once again I checked the SWR. It was 1.4:1—much better.

That day I had a hundred contacts, mostly with Europe. On the next day, a Saturday, morning propagation was bad—very common in this part of the world.

Since the bands were not yet open, I decided to take a walk around Wallis. I enjoyed the Polynesian architecture, the flora and fauna, and the people. The islands were discovered by the Dutch navigator, Captain Wallis, in 1616. The first Catholic missionaries arrived from France in 1837. The island is small and flat. There is a population of 9000, and a radio and television station.

Together with the Horn Islands, Wallis is a French overseas territory. It has two forms of government. Administration is basically French, but at the local level, Wallis is a kingdom, fully recognized and respected by Paris. The King is chosen from members of four royal families and holds traditional power. The Royal Assembly decides upon land, titles, customs and other internal matters.

Early in the afternoon, I arrived back at my station and found the bands totally filled with the WPX SSB contest. I was not thrilled about going into the contest, but I had no other option. With my low power and a vertical antenna I could not compete with monster Japanese and US stations. Only the rare FW prefix would give me a chance to attract attention.

The contest went on for 48 hours. I stayed with it for 14–15 hours and made over 1000 QSOs—not bad.

On Monday, the weather was bad. I was afraid that heavy winds would not allow me to go to Horn Islands—the actual goal of my operations. That night, with Sosefo's help, I took down my antenna and packed my rig to leave for the Horn Islands in the morning. It was a one-hour flight in a Twin Otter.

Before I left Wallis, Sosefo arranged with a friend, a Catholic priest, for me to stay in the Catholic mission and transmit from there. Father Petelo Falelavaki was waiting for me at the airstrip.

**14 QST Canada**

To get to the mission, we had to cross the whole island. The mission consists of a church with a 30-metre steeple and a house for accommodations. Of course, I was in a rush to get on the air. I noticed that the only place for the antenna was the steeple, but I felt as strange asking about this as priest might have been embarrassed by refusing me. Fortunately, I found him agreeable to my suggestion, and we started climbing the tower to check conditions there. The only place I could attach the antenna was on the concrete cross, three metres high atop the steeple. We went back down and collected the antenna and necessary tools, and with the help of a Wallisian boy, we climbed to the top again. After an hour of work, the R5 was secured to the cross.

The station was set up in a room in the mission house. I connected the antenna and found that the manual antenna tuner was broken. Also, something had happened to my desk microphone. Luckily, I had a spare microphone, but I had to work without a tuner.

It was 2341 UTC when I switched on and transmitted on 28.290 MHz, the Canadian 10-metre calling frequency. First to appear: my friend Jerry, VE7BG. I announced to him that the was the first QSO with Futuna Island. It was 1990 March 27 when I activated Horn Islands, OC-118 for IOTA. I felt very proud. The day was spent working the US, South America and Australia, and later Europe and Asia. Propagation was not good, but I managed to make 700 QSOs.

My next and last day in Futuna was bad: hot and sticky weather with showers and extremely poor propagation. I got up several times during the night and went to my station, but the bands were empty. I could hardly copy Japan which usually comes into this part of the world 57.

On March 28 at 2200 UTC, the 10-metre band started to open. I made about 50 QSOs with the US, Canada and Australia. At 0000, propagation collapsed again—bad luck! What made it worse was that I could not stay longer in the Horn Islands. I found Futuna with its white sand beaches, houses and smiling people a little like paradise. I was surprised that, after all my years in the Pacific and seeing so many islands, I could be amazed by this one. Everywhere on the island, I could see my antenna standing proudly on top of the tall church steeple.

At 0400 UTC, I started to transmit again, this time on 20 metres. I copied mainly the US and Canada. Surprisingly, Paraguay was booming into Futuna, 10 over S-9. I worked about 20 ZP stations in a very short time.

At 0600 UTC, 1800 local time, I had an appointment with the King of Sigawe. I paid him a brief visit in the royal meeting house. In his speech, the king expressed his great appreciation for my coming to Futuna, transmitting worldwide and making the island well known. He asked me to pass a message to all amateurs that he would welcome other operators and give them any assistance they needed.

After this visit, I rushed back to my stations for some final transmissions, as next morning I had to go back home to Vanatu. Propagation was not good, but I managed to make about 250 QSOs in just a few hours, mainly with Japan and Europe. The last contact I made was with OH1XX. We went through all the bands, including the new ones.

Next morning at 0500 local time, I closed the station. Father Petelo gave me a lift to the airport and said goodbye with the traditional ula. That was the end of my FW operations. I had made about 3000 QSOs from Wallis and Futuna, contacting 62 countries. And I had accomplished my goal: the activation of Horn Islands, a separate entry in IOTA, a continuation of my World DX Safari Program. —Marek Bladowski, YJ8M



Right: FW/YJ8M on the air from OC-54, Wallis Island: the antenna is in the breadfruit tree.

Below: "With a Little Help from Above...": the R5 vertical is mounted on the steeple of the mission church, Horn Islands (Futuna), OC-118. (YJ8M photos)

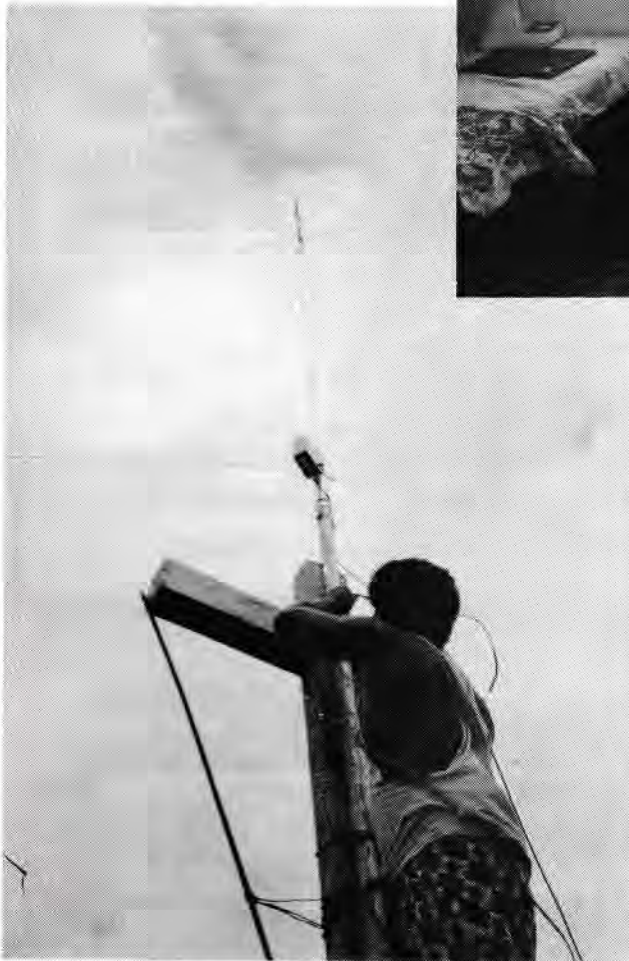

#### REPORT OF THE CRRL REPRESENTATIVE ON THE ARRL CONTEST ADVISORY COMMITTEE

□ On the basis of proposals from VE3CIU, VE1CRC and others, the Contest Advisory Committee (CAC) has recommended that the ARRL Awards Committee give multiplier status to New Brunswick, Nova Scotia, Prince Edward Island, Newfoundland and Labrador in the ARRL DX Contests and the ARRL 10-Metre Contest. Stay tuned for the official announcement. In the meantime, let's hope that VE1, VY2, VO1 and VO2 amateurs increase their participations to keep the multiplier hunters happy during the contests. It's a great chance for amateurs in each of these areas to compete against each other and win some wallpaper for their efforts.

□ On the basis of a proposal from VE7CKF, the CAC has recommended that the ARRL Awards Committee create a separate class for QRP stations participating in the ARRL 10-Metre Contest. However, no additional points for QSOs with QRP stations are recommended. This is consistent with rules for QRP stations in other contests.

□ The 1990 November Sweepstakes Contest will incorporate two new suggestions from CAC. There will be participation

pins, available at a nominal cost, for those who make 100 QSOs or more, and rules will designate slow-speed CW frequencies.

□ Congratulations to the following Canadian amateurs who earned certificates of achievement:

1. In the USSR's RSF 1989 CQ-M (Peace) Contest: VE3NYT, VO1AW and VO5AC.

2. In the 1989 IARU Radiosport Contest: VE1CBF, VE2WAT, VE3BXY, VE3CPA, VE3KP, VE6DZ, VE7EBI (operating VE7EEE), VO1AW and VO2AC.

□ If you have any news for this column, send it along. If you have suggestions for any ARRL or CRRL contests, feel free to write. Your ideas are encouraged. —Garry Hammond, VE3XN

#### NOTES FROM THE CRRL REPRESENTATIVE ON THE ARRL DX ADVISORY COMMITTEE

It's 1990 July 15. During the last two weeks, I have been burning the midnight oil at the local public library, trying to find the roots of the DXCC program and understand where the whole thing started from. It would appear that the formalization of an approved countries list began around 1932-33. The first step was a map in 1934 November *QST* defining continental boundaries.

The first approved countries list was published in 1937 January *QST*. There were four general categories which resulted in a discrete geographical or political entity being considered to be a country. The categories were nations, colonies and protectorates, individual islands and island groups, and islands or island groups that had more than one country governing them.

The DX Century Club (DXCC) was first announced in 1937 September *QST*. A revised countries list appears in 1938 January *QST*. Over the next ten years, World War II intervened. The next revised list appears in 1947 February *QST*. This list was the result of collaboration of G2MI, W6QD and five staffers from ARRL Headquarters.

The post-war DXCC countries list was determined on the basis of: (1) degree of political/administrative independence, (2) geographical separation, and (3) separation by foreign land.

In the late 1950s, the points that we in the ARRL DX Advisory Committee (DXAC) so often refer to appear in print in more detail. I could not find an early reference to point 1 above, but in the 1960 April *QST*, points 2 and 3 were revised and mileages were added.

I would like to know if anyone has a collection of ARRL operating aid No. 7 going back in time. I can find reference to it in the 1950s, but it was not published in *QST*, as far as I can find. —Garth Hamilton, VE3HO





# Century 21 Communications

# 738-0000

Fax Line: (416) 738-1169  
**Store Hours**  
 Monday-Friday: 9 AM-5 PM  
 Saturday: 10 AM-2 PM

	Jane	McLeary Ct
	Credstone	Hwy 7
400		

23 McLeary Ct.,  
 Concord, Ontario

## KENWOOD

**TS 140S/680S**



ECONOMICAL FULL-FEATURED  
 HF TRANSCEIVER  
 TS-680 INCLUDES 6M

**TS 940S/AT**



DELUXE  
 COMPETITION CLASS

**TS 950 SD**



DIGITAL SIGNAL PROCESSING  
 FOR THE CLEANEST TRANSMITTED SIGNAL

**TS 440S/AT**



POPULAR HF TRANSCEIVER  
 WITH OR WITHOUT AUTOMATIC TUNER

**TM 631/731A**



DUAL BAND MOBILES  
 TM631A TM731A  
 2M-220 2M-440

**TH 75A**



**TH 225A**



**TH 25AT**



WE STOCK A COMPLETE LINE OF ACCESSORIES  
 FOR THE KENWOOD HANDHELDS.

**TM 231A**



COMPACT 50 WATT  
 2 METER MOBILE

**IC-765**



COMPETITION GRADE

## ICOM

**IC-781**



SIMPLY THE BEST

**IC-751A**



PERFORMANCE PLUS VALUE

**IC-725**



ECONOMY HF

**IC-735**



PROVEN WINNER

**IC-726**



HF PLUS 6 METERS

AUTOMATIC RANDOM WIRE TUNER AVAILABLE FOR THESE MODELS

**IC-3210**



DUAL BAND MOBILES

## HANDHELDS

**IC-228H**  
 2 METER MOBILE



**IC-2400**



**IC-25AT**



**IC-2GAT**



**IC-32AT**



**IC-24AT**

COMPLETE LINE OF ACCESSORIES FOR ICOM HANDHELDS

**IC-901**  
 Versatile Multi-Band  
 Remote System







## CORES FOR DARF

We have approximately fifty (50) new toroidal cores suitable for wrapping power lines, coax cable, speaker leads, etc. Dimensions are 2-3/8" outside diameter x 1-3/8" inside diameter. Permeability is 850. These have been ideal for suppressing undesirable common-mode RF on consumer appliances. Note that these are not suitable for baluns.

Cost of these toroid cores: \$7 each. We pay the tax and the postage. For each core purchased, \$1 will be donated to the Defence of Amateur Radio Fund (DARF).

We also have three-hundred (300) new toroidal cores with dimensions 3/8" outside diameter x 1/8" inside diameter. These cores are made from Sifferit, a fantastic ceramic material manufactured by Siemens. Permeability is 2000.

Many of these cores can be found in telephones, answering machines and small radios, on speaker leads and even on input leads to security alarm systems and garage door openers. They nicely fit RG-58 coaxial cable to form a choke balun. In this application, at least ten are needed. Radio amateurs know they will

work even though the commercials wrinkle their noses at the notion. Eight or nine turns of evenly spaced #22 wire and you have a broadband choke that works from 2 to 200 MHz—pretty cheap protection.

These cores are priced at \$ 0.75 each, tax and postage included in Canada only. For each core purchases, \$ 0.25 will be donated to DARF.

All sales are final. Cores will be shipped until the supply runs out. This offer will not be repeated: Do your neighbours a favour, and yourself too. Personal cheques and money orders only to Ralph Cameron, VE3BBM, 30 St Remy Dr, Nepean, ON K2J 1A3

## CRRL AMATEUR OF THE YEAR

Nominations are now being accepted for CRRL Amateur of the Year. This award is designed to recognize a Canadian amateur who has made an outstanding contribution over the past year, or one who has consistently contributed to the welfare of Amateur Radio over several years. Deadline for nominations: 1990 December 31. Send your nomination and supporting documentation to the CRRL Secretary c/o

CRRL Headquarters. Winning candidate will be determined by a vote of the CRRL Executive Committee. Name of winner will be announced in the *CRRL News* bulletins and in *QST Canada*. —W W Loucks, VE3AR, CRRL Secretary

## Section News—continued from page 13

Saskatchewan well represented, at the Glacier-Waterton Hamfest. 450 amateurs registered, plus 100 others enjoyed perfect weather. Another busy summer for public service events under the leadership of Clay, VE5AAA. May 27, the Kinsmen Moon-Walk in Regina with VE5s AAA, AGM, AHW, EE and GHC. Wascana Park was the site of the July 1 Wascana Relays with VE5s AAA, AGM, BW, GHC, LV, JML, LV and UU. July 28 was the date for the popular Buffalothon with VE5s AAA, AHW, BW, ELJ, IC and UU. This year, the Travellers' Day Parade became the Buffalo Days Parade. Once again, amateurs volunteered as parade marshalls and communicators. VE5s AAA, EE, JML, IC and OI rode with parade marshalls in golf carts, while VE5s ELJ, TH, and UU drove mobile units in the parade. VE5BW manned headquarters at the Tartan Curling Club, VE5WW was official photographer, and VE5s AHW and RC were on standby. Saskatchewan CRRL officials are planning to visit the Saskatoon ARC in October. 73 to all.

**Com-West  
Radio**

P R E S E N T S A N

8179 Main St.  
Vancouver, BC V5X 3L2  
604-321-1833

ICOM WIN

DAY

Grand  
Prize  
IC-2SAT

**Saturday October 27, 1990**

**9:00 A.M. — 4:00 P.M.**

**Prize Drawing  
each hour. Come  
and register to win.**  
(No purchase necessary to win.)

- Special pricing
- ICOM personnel to demonstrate new equipment
- See the new line of ICOM equipment

ICOM



KENWOOD  
ICOM  
ALINCO  
A.E.A.  
CUSCRAFT  
VIBROPLEX  
BENCHER  
ARRL

# NORHAM RADIO SUPPLY INC.

YAESU  
TEN TEC  
JRC  
DAIWA  
M.F.J.  
KANTRONICS  
UNADILLA  
& MORE !!

## NEW KENWOOD

**NEW** TM-941A tri-band FM transceiver.  
\*Triple Receive Function  
\*Triple Display  
\*100 memory channels each band  
\*Multi-Function Microphone Supplied

**NEW** TM-241A/441A FM MOBILE TRANSCEIVER  
\*High Power 50W(TM-241A), 35W(TM-441A)  
\*20 Multi-Function Memory Channels  
\*Easy-To-Read, Easy-To-Operate Display

**NEW** TH-77A unique handheld VHF/UHF transceiver  
Dual Receive Function with Dual Displays  
Extended Receiver Coverage DTMF Memory for Auto-Dial Operation  
Built-In Dual Tone Squelch System (DTSS)  
Ultra-Compact and Lightweight

## Cushcraft

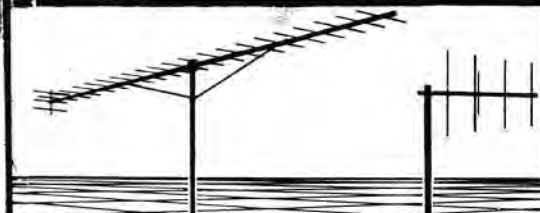

### FM BOOMERS

Our FM Boomers feature the latest wideband technology to give the high performance required for FM and Packet or sideband and CW. There are three high performance models for two meters and two models for the new 220 MHz novice phone band. All are designed for quick, easy assembly and horizontal or vertical mounting.

124WB	144-148 MHz	4 Element	4' BOOMER
215WB	144-148 MHz	15 Element	15' BOOMER
230WB	144-148 MHz	2x15 Element	BOOMER
224WB	220-225 MHz	4 Element	3' BOOMER
225WB	220-225 MHz	15 Element	10' BOOMER

### KENWOOD

**NEW**



**TS-950SD**  
TRANSMIT THE ULTIMATE SIGNAL  
• Digital Signal Processing  
• Dual Frequency Receive  
• Digital AF Filter • 100 Memories  
**CALL FOR DETAILS AND ORDER TODAY!**

### YAESU



**FT-1000**  
THE BEST OF THE BEST  
• 200 Watts Output  
• All Amateur Bands  
• Dual Receive  
• DDS-Direct Digital Synthesis  
**CALL FOR ALL THE DETAILS!**

### ICOM

**SALE PRICED**



**IC-735**  
PROVEN HF WINNER  
• Compact and lightweight  
• 100 Watts Output  
• Noise Blanker  
• General Coverage Receiver  
**CALL TODAY!**

### KENWOOD



**TH-26AT**  
COMPACT 2 METER H.T.  
• 136-173.995 MHz Coverage  
• Dual Tone Squelch System  
• 5 W Capability  
• Automatic Repeater Offset  
**CALL FOR ALL DETAILS!**

### KENWOOD



**TS-140S** AFFORDABLE DX-ing!  
• HF Transceiver With General Coverage Receiver  
• All HF Amateur Bands  
• 100 W Output  
• Compact. Lots of Features

### YAESU

**NEW**



**FT-470**  
COMPACT DUAL BAND FM HANDHELD (2M/70CM)  
21 Memories for Each Band  
Dual VFO's for Each Band  
Up to 5 Watts Power  
Built-in CTCSS  
Built-in 10-Memory DTMF Autodialer

### MFJ SALE MFJ

LARGEST STOCK OF ALL YOUR MFJ FAVORITE ACCESSORIES  
CALL TODAY FOR BEST PRICE



**MFJ-1278**  
Multi-Mode Data Controller

### KENWOOD



**TH-225A**  
HIGHER POWER 2 METER H.T.  
• Now 5 Watts Output  
• Odd Off Sets  
• Wideband Frequency Coverage  
• Same Accessories as TH-215  
**CALL TODAY!**

Mail Order

Visit Our Retail Store

Phone Orders

**VISA** NORHAM RADIO SUPPLY  
4767 STEELES AVE W.  
NORTH YORK, ONT.  
WE TRADE M9L 2W1

STORE HOURS:  
TUES:10-8:00  
WED-FRI:10-6:00  
SAT:10-3:00  
CLOSED SUN & MONDAY

CALL DURING  
STORE HOURS ON  
(416) 745-1000  
OR FAX 24 HOURS  
(416) 745-5651



C.O.D



## Calgary Flood Watch

Reading Calgary ARC's bulletin, *Key Klix*, we recently learned of the contribution that ARES made during a flooding emergency in that city in May. Ken Oelke, VE6AFO, Calgary EC and Alberta SEC, wrote as follows:

"On May 26 at 1645, Richard Depatie of the City of Calgary Disaster Services, called the EC to discuss the possible need to activate ARES members for flood watch duty. He was getting conflicting reports from other agencies and he wanted to have ARES on standby in case he needed more complete information.

"At 1700, a "GREEN callout" was initiated (a warning of a possible callout, giving ARES members time to prepare themselves and organize their affairs prior to reporting for ARES duty, and a net was established on repeater VE6RYC. Net control duties were turned over to Randy, VE6BOJ. Within 35 minutes, 29 check-ins were standing by for further instructions from the EC.

"After everyone had checked in from their respective quadrants, each was requested to indicate their approximate time of availability. Then the net was reduced to informal status and the EC requested all ARES members to maintain a "holding pattern", making sure they checked out with net control if they left the net.

"At 1930, Depatie called again and asked for the dispatch of flood watch communications crews to several points around the city. The net was activated again, and I issued a bulletin naming various locations where a flood watch was requested. Net control, Randy, VE3BOJ, dispatched Larry, VE6KC, to watch at Elbow River around the 4th Street Bridge and Holy Cross Hospital. Russ, VE6CGO, was already reporting on flood conditions in the 37th Street and 66th Avenue, SW area. Roy, VE6RH, was dispatched to the confluence of the Elbow and Bow rivers. Doug, VE6CID, watched conditions at Zoo Bridge over the Bow River, and the weir area downstream. Arnie, VE6AXB, ably handled the Cochrane Bridge. He also cruised around the Bearsaw Dam area. Jim, VE6JIM, and Murray, VE6MST, handled the watch at Cushing Bridge. Don, VE6CG, Jim, VE6AUZ, Jack, VE6CT, and Henning, VE6KX, also provided checks from various points in that area.

"At 2030, Depatie was given a complete report on flood conditions within the city. He was much relieved to learn that all was not as gloomy as anticipated. He asked for another report within a couple

of hours. All indications from the second report was that water levels were not rising. Indeed, in some areas, they were dropping slightly. Satisfied that no further trouble seemed likely, Depatie asked to have all ARES members stand down from their duties. Depatie was astonished to learn that amateurs had manned eight check points and that 33 amateurs in all had offered their assistance."

An informal debriefing concluded that, among other things, more care should be used with the word "break". Ken says that this is really a proword to indicate that you have an emergency. A "double break"

is recognized as a distinctive emergency call and all other traffic immediately stands by for the traffic indicated by the "double break". Be very careful using "break". It has a very powerful meaning. If you must break into a net with information or traffic, give your callsign only. During heavy net activity, giving your callsign suffix may suffice. After this, don't persist with further calls. Net control will respond with the words, "Stand by" and acknowledge you as soon as he or she is finished with other traffic. If you are not acknowledged then, give another call. You may have doubled with someone

### Field Organization Reports July 1990

#### CRRL Section Emergency Coordinator Reports

Reports were received from the following SECs (DECs and ECs reporting to SECs are listed in brackets) denoting a total ARES membership of 996.

Reporting	ARES Members
VE3GV (VE3s AFP, EFX, FFD, GNW, JHW, JJA, KDV, LJV, LKI, LPM, MB, SV, TNL)	592
VE4JR	50
VE6AFO	265
VE7FB	89

#### CRRL Section Traffic Manager Reports

Call	Orig	Rcvd	Sent	Divd	Total
VE1ALU	1	5	6	0	12
VE1YS	0	3	4	0	7
VE1DLC	1	4	1	0	6
VE2BP	4	14	17	14	49
VE2WH	2	11	9	13	35
VE2GOP	0	11	11	0	22
VE2ALE	0	3	1	3	7
VE3ORN	2	48	44	10	104
VE3BDM	0	73	11	2	86
VE3CYR	0	53	22	1	76
VE3GNW	0	34	24	1	59
VE3ISD	2	16	33	0	51
VE3AJN	0	17	9	1	27
VE3GT	1	6	17	1	25
VE3SB	0	10	9	3	22
VE3KXB	0	5	9	0	14
VE3LPM	0	4	8	14	16
VE3WV	0	3	8	1	12
VE3FGU	0	2	5	0	7
VE3BAJ	0	0	6	0	6
VE3DVE	1	1	3	0	5
VE3NVJ	0	2	3	0	5
VE3KCZ	0	1	2	0	3
VE4JA	10	118	40	60	228
VE4JR	0	20	20	8	48
VE4STU	2	4	20	4	30
VE4TE	0	22	4	0	26
VE6XG	0	18	12	4	34
VE6CE	0	6	16	0	22
VE6CPP	-	-	-	-	22
VE6AKY	-	-	-	-	12
VE6GUS	-	-	-	-	11
VE6ABC	-	-	-	-	7
VE7BNI	21	82	156	32	291
VE7ANG	1	88	51	10	150
VE7XA	2	15	21	5	43
VE7BCL	0	18	19	4	41
VE7OM	0	14	16	0	30
VE7AVA	0	6	13	0	19
VE7FB	0	5	4	1	10

Call	Orig	Rcvd	Sent	Divd	Total
VE7FVG	0	0	0	8	8
VE7BVZ	0	4	3	0	7

#### National Traffic System

Net (Mgr)	Sess	QNI	QTC
APN (VE1YS)	31	101	23
KTN (VE3AJN)	13	31	9
OLN (VE3POJ)	26	425	26
OPN (VE3BDM)	31	461	93
OQN-D (VE3ORN)	30	67	16
OQN-E (VE3CYR)	25	73	56
OQN-L (VE3GSQ)	10	2	0
MTN (VE4IX)	74	73	14
MEPN (VE4LB)	31	767	11
MMWX (VE4TE)	31	307	26
AJRAAURA 2 (VE4s WR/FP)	31	431	24
BCEN (VE7EJU)	31	653	269

#### Brass Pounders' League

This listing is available to amateurs who report to their SM a traffic total of 500 or a sum of originations and delivery points of 100 or more for any calendar month. All messages must be handled on amateur frequencies, using standard ARRL-CRRL form, within 48 hours of receipt.

BPL: None this month

#### Public Service Honour Roll

This listing is available to amateurs whose public service performance during the month indicated qualifies for 60 or more points in the following nine categories (as reported to their SM). Please note maximum points for each category: (1) Checking into CW nets, 1 point each, max 30; (2) Checking into phone/RTTY nets, 1 point each, max 30; (3) NCS CW nets, 3 points each, max 12; (4) NCS phone/RTTY nets, 3 points each, max 12; (5) Performing assigned NTS liaison, 3 points each, max 12; (6) Delivering a formal message to a third party, 1 point each, no max; (7) Handling an emergency message, 5 points each, no max; (8) Serving as an EC or NM for an entire month, 5 points max; (9) Participating in a public-service event, 5 points each, no max. Amateurs who qualify for Public Service Honour Roll 12 consecutive months, or 18 months out of a 24-month period, will be awarded a special certificate from CRRL Headquarters.

PSHR: VE3ORN (99), VE3BDM (98), VE3GNW (92), VE3CYR (66), VE4JA (166), VE4LB (108), VE4STU (87), VE4IX (68)

#### Service and Specialized Nets

Independent Net Managers: Your monthly reports are welcomed. Send to CRRL, Box 7009, Station E, London, ON N5Y 4J9.

Net (Mgr)	Sess	QNI	QTC
ARES Canada (VE3GV)	5	98	1
ARES Ontario (VE3GV)	1	5	0
CRRL ONTARS (VE3FQV)	31	8462	0



the first time. But don't call, "Break!"

We certainly agree with Ken's conclusion: "This was a good callout exercise for all ARES members. It proved that previous tests of the telephone tree would leave little doubt as to what our members should be doing. The pressure is much less when one is drilled in these things."

#### NEW ARES GROUPS

In recent months, we have received requests from both ends of the country for help in organizing an ARES group. "Chip" Chapman, VE1KGB, is secretary-treasurer of Greenwood (Nova Scotia) ARC. He wrote that his club is most interested in organizing itself to provide emergency communications, and needed some help in getting started. Kim Olfert, VE7DZV, made a similar request from BC. Kim is Terrace Zone Amateur Radio Chief of the Provincial Emergency Program. He wrote in "In an attempt to provide emergency communications for the residents of Northern BC, the radio amateurs here have been looking for ideas and methods of plan development. We had hoped that our provincial government would provide some guidelines, but little has transpired."

We were happy to be able to send to each a number of suggestions and other information. We hope to be able to report, in a future column, the progress that both groups have made.

A year ago, had a similar request from Dave Massey, VE7DWR. His QTH is Saltspring Island. Saltspring has a population of some 4000, forty of whom are amateurs. The big concern is the possibility of a major earthquake. This concern was heightened by the San Francisco earthquake just before Dave wrote. We provided Dave with some information to help him get his group going. Two recent notes show that things are moving along nicely:

"We have had several tabletop exercises. We are working on preparation of an operator's manual and on a list of equipment to be purchased. The latter has been made possible by a grant to our club from the Capital Regional Board. The grant, which amounts to about \$2000, will be spent on VHF equipment for the command centre, some commercially-built antennas and a backup power generator.

Dave enclosed a newspaper clipping about his group's participation in June Field Day. After describing the portable installation which was in a high school, football field, the clipping continued:

"This was a contest to find out how many stations Saltspring amateurs could reach in a given time, but it might easily have been an emergency situation with radio equipment set up at the site of an accident, and with local hams in touch with hospital, police and other response teams.

"Island residents may like to know that there are some 40 radio amateurs in the community ready to help in event of an emergency. About half of this number are organized into a formal club with communications equipment which can be operated in a situation where power and telephone services have been destroyed. Members, however, are quick to point out that the club is not there to replace equipment used by police, Coast Guard and fire departments, which have their own radios. Radio amateurs can help by providing a message service and by assisting authorities when equipment is out of range or incompatible.

"Radio amateurs have long been known for being of help in emergencies and the Salt Sprint Radio Club aims to keep up this reputation. Club members hold a weekly practice emergency net on the air, meet regularly for training sessions and work with those groups on the island directly concerned with civil disaster. There is an emergency plan for Saltspring, and a temporary command centre has been selected. The Provincial Emergency Program (PEP) will offer help at the time of the disaster, although the island, for the first few days, would be on its own. During those critical days, radio amateurs hope to be in constant touch with PEP and, at the same time, to work either at the command centre or directly with the response teams at the site of the emergency."

Our congratulations to Dave, who is the club's communications officer, Dan Giles, VE7QM, the club's president, and the rest of the Saltspring gang for an excellent start. —Bob Boyd, VE3SV

## Renew Your Membership Now—and Beat the GST!

Why pay more later? Renew your CRRL membership now and beat the GST on magazines. You'll receive *QST Canada* and *QST* (either or both) monthly journals, free CRRL Outgoing QSL Bureau, and discounts on CRRL, ARRL and RSGB books and materials. Your membership supports many important services to Canadian Amateur Radio: representation to DOC and other government agencies, representation to IARU; Field Organization (NTS, ARES, OBS) for public service, the incoming QSL bureaus and much, much more.

Count me in! Here's my application for CRRL membership!

- Basic CRRL membership: \_\_\_\_\_ years at \$15 per year: \_\_\_\_\_
- QST Canada*: \_\_\_\_\_ years at an additional \$12 per year: \_\_\_\_\_
- ARRL's *QST*: \_\_\_\_\_ years at an additional \$31 per year: \_\_\_\_\_
- Total amount enclosed: \_\_\_\_\_

Name: \_\_\_\_\_ Call: \_\_\_\_\_

Address: \_\_\_\_\_

Postal Code: \_\_\_\_\_

Please enclose payment. Offer expires 1990 December 15. Thank you for your support.

**The Canadian Radio Relay League, Inc.**  
Box 7009, Station E, London, ON N5Y 4J9



*ARES is a branch of the CRRL Field Organization, although you do not have to be CRRL member to take part. Check with your CRRL Section Manager or Section Emergency Coordinator for details.*

*We hope that this column, which also appears in The Canadian Amateur, will serve as an ongoing source of news and information about emergency preparedness activities in Canada. ARES members, particularly ECs, are invited to send information on what they are doing. We will share this information in future columns with the objective of increasing our ability to serve, should disaster strike.* ■

#### MOVING?

All copies of *QST* for Canadian addresses and all copies of *QST Canada* are processed at CRRL Headquarters. If you are moving, please send your change of address notice to CRRL, Box 7009, Station E, London, ON N5Y 4J9. We appreciate eight weeks' notice if possible. Please quote your call sign or the seven-digit number on your mailing label. ■



# NEW YAESU PRICELIST

16 SEP 1990 (PRICES SUBJECT TO CHANGE WITHOUT NOTICE)

## HF TRANSCEIVERS & ACCESSORIES

FT-1000 Includes DDS, 200W, HD PS, Dual Freq Rx, 100 Mem, Auto Tuner Keyer, Hand Mike, XF-A 2kHzSSB & XF-B250HzCW Filters	\$3999
FT-1000D above plus BPF-1, TXCO-1, XF-C, XF-D, XF-E	\$5199
XF-C 455kHz 2.4kHz SSB Crystal Filter	\$ 229
XF-D 455kHz 2.0kHz SSB Crystal Filter	\$ 229
XF-E 455kHz 500Hz CW Crystal Filter	\$ 229
XF-F 455kHz 250Hz CW Crystal Filter	\$ 239
XF-455MC 455kHz 600Hz CW Crystal Filter	\$ 239
BPF-1 Dual Band-Pass-Filter Board for Cross-Band Service	\$ 239
TXCO-1 Temperature Compensated Crystal Oscillator	\$ 339
FT-767GX HF All Mode Xcvr (Optional 2M, 6M, UHF Boards) Includes Power Supply, Auto Antenna Tuner, Hand Mike	\$2699
FT-650 24/28/50MHz HF Xcvr DDS 100W 100Mem 24.5-56.0MHz Rx	\$1899
FT-757GX/II HF All Mode Xcvr with Hand Mike	\$1299
FT-747GX Compact, Lightweight, HF All Mode Xcvr with Hand Mike	\$ 999
FL-7000 500W Automatic Solid State HF Linear Amplifier with Auto Tuner	\$2999
FC-757AT HF Auto Antenna Tuner	\$ 559
FC-1000 Full Coverage Auto Antenna Tuner (Long Wire or Whip)	\$ 729
FP-700 Standard 20 amp Power Supply with Speaker	\$ 319
FP-757HD Heavy Duty 20amp Power Supply with Speaker (30 min rating)	\$ 399
SP-767 Speaker with Audio Filters	\$ 149
SP-767P Speaker with Phone Patch	\$ 199
SP-5 Speaker with Audio Filters to match FT-1000	\$ 199
LL-5 Phone Patch Unit for SP-5	\$ 199
MD1-88 Deluxe Desk Mike with Up/Down Scan	\$ 175
MH1-88 Hand Mike with Up/Down Scan	\$ 49
YH-55 Deluxe Communications Headphones	\$ 49
YH-77 Lightweight Communications Headphones	\$ 40
YH-77ST Lightweight Communications Headphones For Dual Rx	\$ 79
DVS-2 Digital Voice Recording Modula for FT-1000	\$ 399
RMK-747 Remote Kit for FT-747 Front Control Panel	\$ 289
FEX-767-2M Module for FT-767	\$ 329
FEX-767-6M Module for FT-767	\$ 269
FEX-767-70A 440-450MHz Module for FT-767	\$ 399
FEX-767-70B 430-440MHz Module for FT-767	\$ 399
FIF-232C CAT Interface for RS-232 port Computers	\$ 139
FM-747 FM Module for FT-747	\$ 75
FRB-757 Relay Box for FT-757 and Amplifier	\$ 25
FAS-1-4R Remote Antenna Switch for FC-102 FC-757AT FL-7000	\$ 189
FTS-8 CTCSS Tone Squelch Unit for FT-767 FT-736 FT-4700	\$ 85
MMB-20 Mobile Mount for FT-757	\$ 40
MMB-38 Mobile Mount for FT-747	\$ 25
MMB-42A Metal Case for FT-747	\$ 139
TXCO-747 Temperature Controlled Crystal Oscillator	\$ 65
YS-60 1.8-60MHz 2kW PEP/RMS SWR/Watt Meter	\$ 189
YS-500 140-525MHz SWR/Watt Meter	\$ 149

## VHF/UHF MOBILES & ALL-MODES

FT-736R 2M/70cm 25 Watts SSB CW FM Xcvr (Optional 6M 220 1.2GHz) Comes with Hand Mike and CW Filter, built-in P.S.	\$2199
FEX-736-6M Module	\$ 399
FEX-736-220 MHz Module	\$ 449
FEX-736-1.2GHz Module	\$ 799
FVS-1 Voice Synthesizer Board	\$ 59
Keyer B Internal Electronic Keyer for FT-736	\$ 39
TV-736 Fast Scan TV (ATV) Mod/Demod for 1.2GHz	\$ 229
E-736 DC Cable for FT-736	\$ 25
FT-4700RHT Dual Band VHF/UHF Trunk Mount Mobile, 50/40 Watts, with YSK-4700, CTCSS Enc/Dec both Bands, MH-15C8 TTMic	\$ 899
FT-212RH 2M 45 Watt Mobile with CTCSS Enc/Dec, MH-15C8 TTMic	\$ 479
FT-712RHT 70cm 35 Watt Mobile with CTCSS Enc/Dec, 15C8 TTMic	\$ 599
FT-912RH 1.2GHz 10 Watt Mobile with CTCSS Enc/Dec, 15C8 TTMic	\$ 699
FT-290R/II 2M Multi-Mode 25 Watt Mobile FM/SSB/CW, MH-15C8 TTMic	\$ 749
FT-690R/II 6M Multi-Mode 10 Watt Mobile FM/SSB/CW, MH-15C8 TTMic	\$ 899
FT-790R/II 70cm Multi-Mode 25 Watt Mobile FM/SSB/CW, 15C8 TTMic	\$ 819
AD-3 Antenna Duplexer 2M/70cm	\$ 75
CSC-19 Vinyl Case for FT-x90R/II series	\$ 25
DVS-1 Digital Voice Storage Unit for FT-x12 series	\$ 159
FBA-8 C-Cell Holder for FT-x90R/II series (makes them portable)	\$ 50
FTS-7 CTCSS Unit for FT-x90R/II series	\$ 60
FTS-12 CTCSS Decode Unit for FT-x12 series	\$ 85
MH-15D8 TouchTone Mike with 10 Memory Autodialer	\$ 119
MMB-31 Mobile Bracket FT-x90R/II series	\$ 39
NC-28B Wall Charger for FBA-8	\$ 19
YSK-4700L 16' Remote Kit for FT-4700	\$ 79

## ROTATORS

G-250 Light Duty 4 Sq.Ft. (1-1.5" Mast Diameter)	\$ 139
G-400RC Light-Medium Duty 11 Sq.Ft.	\$ 289
G-800S Medium-Heavy Duty 20 Sq.Ft.	\$ 399
G-800SDX Same as G-800S but with Presets	\$ 499
G-1000SDX Heavy Duty Deluxe 22 Sq.Ft.	\$ 589
G-5400B Az-El Light-Medium Duty 11Sq.Ft. (Includes Separation Kit)	\$ 639
G-5800B Az-El Medium Duty 16 Sq.Ft. (Includes Separation Kit)	\$ 739
G-500A Elevation Rotator Medium Duty 16 Sq.Ft.	\$ 319
GS-065 65mm Thrust Bearing	\$ 69
GS-050 50mm Thrust Bearing	\$ 39
GC-038 Lower Mast Clamp for G-400/800/1000/5400/5800	\$ 39

## DUAL-BAND, VHF & UHF HANDHELDS

FT-470 2M/70cm DualBand with DTMF, CTCSS Enc/Dec, FNB-17 Nicad NC-28B Charger, CSC-43 Case, Belt Clip	\$ 569
FT-411E New Enhanced 2M Handy with DTMF, CTCSS Enc/Dec, Belt-Clip FNB-17 Nicad, NC-28B Charger, CSC-35 Case	\$ 469
FT-811 70cm Handy with DTMF, CTCSS Enc/Dec, FNB-17 Nicad, CSC-35 Case, NC-28B Charger, Belt Clip	\$ 489
FT-911 1.2GHz Handy with DTMF, CTCSS Enc/Dec, FNB-17 Nicad, CSC-35 Case, NC-28B Charger, Belt Clip	\$ 599
FT-33R 220MHz Handy with FNB-12 Nicad, NC-18B Charger, CSC-28	\$ 399
FBA-17 Battery Case for 6AA Cells	\$ 20
FNB-12S New 12V Nicad, 600mAh (High Power Nicad)	\$ 85
FNB-14 7.2V Nicad, 1000mAh (Long Life Nicad)	\$ 70
FNB-17 7.2V Nicad, 600mAh (Standard Nicad)	\$ 59
FTS-12 CTCSS Encode/Decode Board for FT-x3R Series	\$ 85
FTS-17 CTCSS Encode/Decode Board for FT-x11, FT-470 Series	\$ 85
FTT-4 DTMF TouchTone Pad Encoder for FT-x3R Series	\$ 69
LCC-25 Leather Case for FT-x3R, FT-x11 with FNB-12, 12S, 14, 17	\$ 49
LCC-27 Leather Case for FT-470 with FNB-17, FT-x3R with FTT-4	\$ 49
LCS-2 Swivel Mount for LCC-25/27, To unhook turn radio upside down	\$ 19
MH-12A2B Speaker Mike for all above Radios	\$ 59
MH-18A2B Small Speaker Mike for all above Radios	\$ 49
MH-19A2B Mini Earpiece/Lapel Mike for all above Radios	\$ 49
MMB-32A Mobile Hanger Bracket for all Radios except FT-470	\$ 25
MMB-46 Mobile Hanger Bracket for FT-470	\$ 25
NC-18B Wall Charger for FNB-12, 12S, FNB-4, FNB-4A	\$ 19
NC-29 Desk Quick Charger for FNB-10, 11, 12, 12S, 14, 17	\$ 99
NC-33 Desk Top Gang Charger for 6 FNB-10, 11, 12, 12S, 14, 17	\$ 399
PA-6 Mobile DC Adaptor with Cigar Cable for FT-x11 FT-x3 FT-470, will also charge the following nicads FNB-10, 14, 17	\$ 35
PA-7 Battery - Radio Separation Cable for FT-x11 FT-x3 FT-470	\$ 45
YH-2 Vox Headset, Both Speaker and Boom Mike for x11 x3 x09 x03 727	\$ 45
CLIP-1 Belt Clip for all small type Handys	\$ 9

## RECEIVERS

FRG-8800 General Coverage HF Receiver, 12 Mem, 100kHz-30MHz	\$ 949
FRG-9600 Communications Receiver 60-905MHz, 100 Memories	\$ TBA
DC-8800 DC-Kit for FRG-8800	\$ 15
VU-9600 Video Output for FRG-9600	\$ 35
FRA-7700 Indoor Active Antenna for FRG-7700, FRG-8800	\$ 99
FRT-7700 Antenna Tuner for FRG-7700, FRG-8800	\$ 119
FRV-8800 118-174MHz VHF Converter for FRG-8800, Mounts Inside	\$ 159
PA-4B AC Adaptor for FRG-9600	\$ 29

The items listed below are still available in LIMITED QUANTITIES. Some may require SPECIAL ORDERS. If you see some Accessories for your Radio, order them now, they may not be available next month !!

FBA-5A Battery Case that Holds 6AA Batteries for FT-x03 FT-x09 FT-727	\$ 25
FNB-4A Nicad Battery 12V 500mAh for FT-x09, FT-727	\$ 95
FNB-2A Nicad Battery Slide-In Type for FT-207, FT-208, FT-708	\$ 49
FTS-6 CTCSS Enc/Dec Board FT-x09, FT-727	\$ 85
PA-3 DC-DC Adaptor and Charger for FT-x08, FT-x09, FT-727	\$ 49
NC-15 1 Hour Desk Charger for FNB-3, FNB-4, FNB-4A	\$ 159
NC-25 1 Hour Desk Gang Charger for (10) FNB-3, 4, 4A, "CLOSEOUT"	\$ 159
NC-8A Quick Desk Charger for FT-208, FT-708	\$ 159
YM-50 TouchTone Mike for FT-x30R, FT-x90R	\$ 79
NC-9B Wall Charger for FT-207, FT-x08, FNB-3	\$ 19
726-HF Module for FT-726, 10-15M	\$ 439
726-2M Module for FT-726	\$ 399
726-6M Module for FT-726	\$ 499
726-70A 430-440MHz Module for FT-726	\$ 699
726-70B 440-450MHz Module for FT-726	\$ 699
726-SU Satellite Unit for FT-726	\$ 269
QTR-1 World Clock	\$ 59
BP-4W Alexander Equivalent to FNB-2 Nicad for FT-207, 208, 708	\$ 39

ATLANTIC HAM RADIO LTD. has worked hard in the past few months to obtain the best pricing for you from YAESU. I'm sure you will agree that the prices above reflect a significant DECREASE in YAESU pricing. You will note that some prices have decreased up to 30% while other items have many things added which used to be optional extras at a price lower than the stripped down version. All HF transceivers now come standard with Hand microphones. The YAESU distributor for Canada is now YAESU USA. ATLANTIC HAM RADIO LTD. will supply Warranty service for YAESU products THAT WE SELL. Make sure you buy your YAESU products from a dealer who can service them otherwise you may have to return them to YAESU USA in California. Since our move to larger quarters at 368 Wilson Ave we now have a FULL TIME Technician on staff for your repairs. ANOTHER FIRST FROM ATLANTIC HAM RADIO LTD. TO SERVE YOU !!

**USED GEAR WITH 30 DAY 100% WARRANTY**  
 YAESU FT-767GX3 1999; YAESU FT-9608 1999; YAESU FT-ONES1799  
 YAESU FT-102 \$899; YAESU FV-102DM \$349; TEMPO 2020 w/6 \$499  
 KENWOOD TS-120 \$699; KENWOOD TS-130 \$799; ICOM U-16 \$599;  
 YAESU FT-767MC \$299; YAESU FT-209HF \$299; MFJ-486 \$199;  
 KENWOOD TH-708R NO NICAD \$199; YAESU FT-767-2M \$269; MFJ-313 \$49;  
 MFJ-482 \$125; MFJ-1274 \$149; YAESU SP-102 \$99;

Insured Shipping and Handling - Please add 2% (\$5.00 Minimum) to all orders. Some Heavy or Long items are subject to freight collect. CANADIAN RESIDENTS add 7% GST (after Jan 1, 91) and ONTARIO RESIDENTS add GST and 8% SALES TAX after adding shipping. (Prices on items which include GST will decrease on Jan 1, 91) All prices are subject to change without notice. E.O.E. Please send 2 first class stamps for Catalogue and information requests. Special prices are based on Cash or Cheque with Order. COD and Credit Card orders add 2% to special prices. Atlantic Ham Radio will pass on FST reductions offered Jan 1, 91. If our suppliers also do this, pricing on items with FST will be about the same as prices without FST and GST added.

**ATLANTIC HAM RADIO LTD**  
**368 WILSON AVE.**  
**DOWNSVIEW, ONT.**  
**M3H 1S9**  
 HOURS: Tue-Fri 10-6  
 Saturday 10-2  
**(416) 636-3636**  
 FAX 631-0747



# ONLY ICOM COULD BUILD THIS MANY FEATURES INTO SUCH A TINY RADIO

## ICOM'S AMAZING NEW MINI FM HANDHELDS

ICOM's new "S Series" mini handhelds deliver top performance on the 144, 220 and 440MHz bands with super easy operation and a kaleidoscope of features. Built to fit your needs today, tomorrow, anywhere and anytime.



**Wide Frequency Coverage.** Plenty of overlap for scanning, monitoring, CAP and MARS use. IC-2SA/IC-2SAT: 138-174 MHz Rx. IC-3SAT 220-225MHz Rx. IC-4SAT: 440-450 MHz Rx. All units transmit all U.S. Amateur bands.

**Flexible Size And Power.** The IC-2SA packs 2.5 watts with supplied BP-82. The IC-2SAT, 3SAT and 4SAT's internal battery packs 2 watts of output on high power. All models deliver five watts when powered via optional BP-85 battery pack or via top-mounted 13.8 volt socket. A small rig with a big punch!

**48 Memories.** Store your present frequencies and expand your future interests. Offset frequencies are independently programmed in memory channels 0-9. Memories 10-47 use offset frequency contents of the VFO. Also includes soft-sector memory masking. Use only the number of memories you need!

**Band and Memory Scanning** with programmable limits, memory skip

function, plus selectable pause times while scanning. Additional features include:

**Automatic Power Shut-off.** Built-in programmable timer automatically switches off transceiver when you forget.

**Optional DTMF Paging Function.** Silently monitors any selected frequency for your preprogrammed 3-digit DTMF-keyed calls, then beeps and displays calling station's code.

All ICOM's "S Series" handhelds are supported by an extensive line of optional battery packs, chargers, cases, speaker/mics and other accessories. See the exciting new ICOM mini-series handhelds at your authorized ICOM dealer today!

ICOM America, Inc. 2380-116th Ave. N.E. Bellevue, WA 98004  
**Customer Service Hotline (206) 454-7619**  
 3150 Premier Drive, Suite 126, Irving, TX 75063  
 1777 Phoenix Parkway, Suite 201, Atlanta, GA 30349  
 ICOM CANADA, A Division of ICOM America, Inc.  
 3071 - #5 Road, Unit 9, Richmond, B.C. V6X 2T4 Canada

All stated specifications are subject to change without notice or obligation. All ICOM radios significantly exceed FCC regulations limiting spurious emissions. 2SAT969

**Four Power Selections**

**10 Memory DTMF Auto-dialer**

**DC Socket For Charging and Mailing**

**24 Hour Clock With Timer**

**48 Memories**

**ACTUAL SIZE**

**Easy Knob or Keypad Frequency Selection**

**Optional Battery Packs Very Size, Power Output**

**ICOM**  
 First in Communications