

B. Sandbrook, 3ATI,
~~Box 56, Terminal "A",~~
Toronto, Ont.

159 WILDWOOD CRESCENT

QUESTION:

What is a Ham Band?

ANSWER:

Just what you regular readers know it is.

Like all specialized fields amateur radio has a language all its own. It's all "Greek" to the outsider. But not so, the G-E monogram on the goods he buys.

The outsider and the radio ham look to the G-E monogram for fine performance, accuracy, precision and lasting service.

- Receiving Tubes
- Transmitting Tubes
- Phototubes
- Industrial Tubes
- Alnico Permanent Magnets

- Capacitors
- Insulating Materials
- Transformers
- Broadcasting Equipment
- Plastics



CANADIAN GENERAL ELECTRIC CO. LIMITED
HEAD OFFICE: TORONTO

Printed by Charters Publishing Company, Limited, Brampton, Ontario.



XTAL



Published by
THE CANADIAN AMATEUR RADIO OPERATORS' ASSOCIATION
LEASIDE, ONTARIO

A Few of the Popular Plate
and Filament Transformers

HAMMOND

HAS AVAILABLE FOR YOUR
NEW TRANSMITTER

FILAMENT TRANSFORMERS

- 1125—Two 5 Volt, 13 amps. C.T.
- 1128—6.3 volts, 5 amps. C.T.
- 1129—6.3 volts, 10 amps. C.T.
- 1141—10 volts, 5 amps. C.T.
- 1144—10 volts, 10 amps. C.T.

PLATE TRANSFORMERS "X" MTG.

- 724—750-0-750 v. sec. 200 MA. D.C.
- 726—890-0-890 v. sec. 175 MA. D.C.
- 728—1000-0-1000 v. sec. 150 MA. D.C.
- 732—1250-0-1250 v. sec. 200 MA. D.C.
- 733—1250-0-1250 v. sec. 300 MA. D.C.

More Details Will Be Found In New 1946 Catalogue Available Soon

CANADA'S MOST COMPLETE LINE OF AMATEUR TRANSMITTING
EQUIPMENT

DISTRIBUTED BY LEADING JOBBERS FROM COAST TO COAST

VE3HC

HAMMOND MANUFACTURING COMPANY

Limited

GUELPH · ONTARIO · CANADA

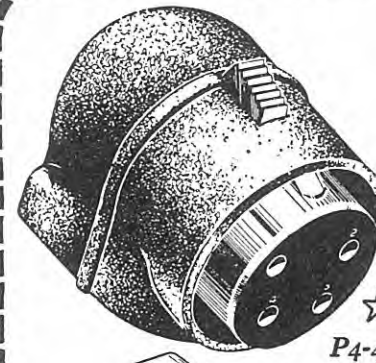

★
P4-41

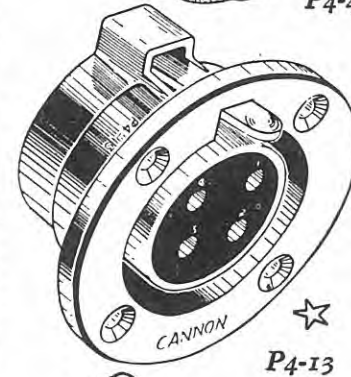

★
P4-13

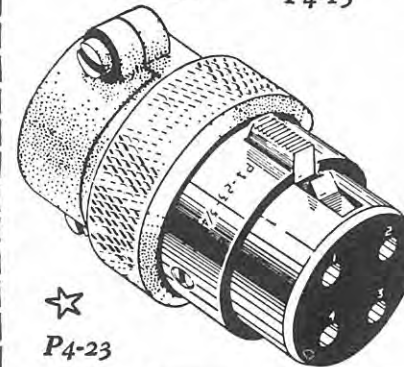

★
P4-23

THREE STAR PERFORMERS FOR ELECTRONIC LOW LEVEL CIRCUITS

PERFORMANCE in connection and disconnection with Cannon Connectors is an advantage endorsed by thousands of users over many years. A leading feature is the "latch-lock."

Types shown here have four 30-amp. contacts accommodating No. 10 B&S stranded wire. Also available in 1, 2, 3, 5, 6 and 8 contact arrangements. The eight contact insert carries 15-amp. contacts accommodating No. 14 B&S stranded wire.

Many other Type "P" styles as well as "O", "X", and "XK" are found in the P & O Bulletin which will be sent free to you upon request. Address Cannon Electric Co. Ltd., 2451 Danforth Ave., Toronto, Ontario.



CANNON ELECTRIC

Cannon Electric Company, Ltd., Toronto, Canada

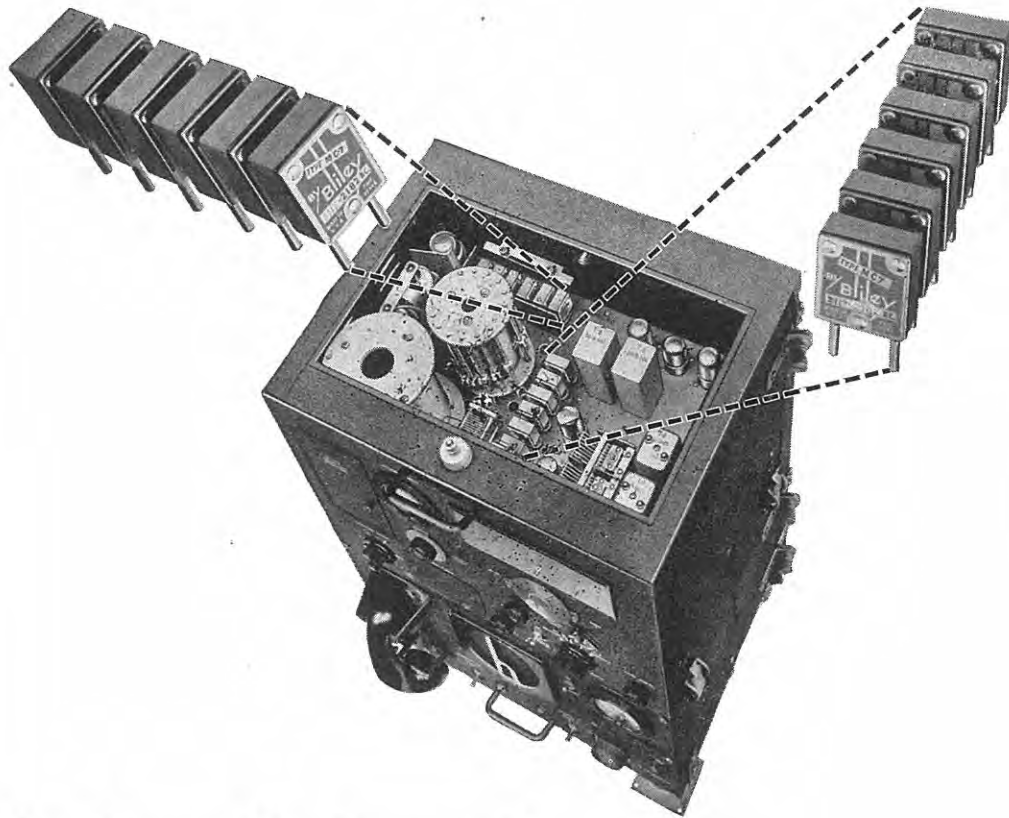

The 6 operating frequencies

are BLILEY CRYSTAL-controlled

For dependable communications on the high seas here is a battle-tested set incorporating every modern feature that experience has shown to be most desirable for ship-to-shore and ship-to-ship radio-telephone service.

The six Bliley crystal-controlled operating frequencies permit instant and positive channel selection in both

transmitter and receiver.

The Bliley *acid etched** Crystals used in this Hallicrafters HT-14 set were designed to meet specific objectives in the operation of two-way radio-telephone communications. They, too, have been thoroughly battle-tested.

It's a habit with most communications engineers to

specify Bliley for all crystal requirements. This is particularly true when new applications and complex designs require technical excellence in every component. There is no substitute for the 15 years of experience offered by Bliley craftsmen and engineers.

+

**Acid etching quartz crystals to frequency is a patented Bliley process.*

Do more than before...

buy **extra** War Bonds.

BLILEY ELECTRIC COMPANY
UNION STATION BUILDING • ERIE, PENN



Bliley

CRYSTALS

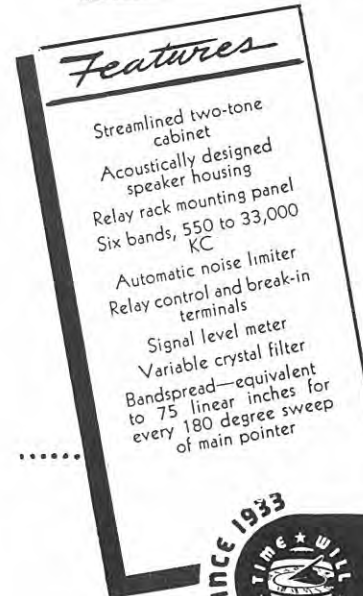

Features

- Streamlined two-tone cabinet
- Acoustically designed speaker housing
- Relay rack mounting panel
- Six bands, 550 to 33,000 KC
- Automatic noise limiter
- Relay control and break-in terminals
- Signal level meter
- Variable crystal filter
- Bandspread—equivalent to 75 linear inches for every 180 degree sweep of main pointer

★
With the new RME 45 you'll have peak performance on the high as well as the low frequencies. There's no secret about how it was done—even though some of the experience has been gained while producing for the Armed Forces.

★
It was accomplished by the use of loctal tubes . . . shorter leads . . . reduced distributed capacity . . . temperature compensating padders . . . and a score of additional refinements—each making its individual contribution to increased efficiency.

★
The RME 45 combines careful workmanship with ease of operation, sound engineering and brilliant performance.

Literature Describing the RME 45 will be sent on request



RME FINE COMMUNICATIONS EQUIPMENT
RADIO MFG. ENGINEERS, INC.
Plover 6, Illinois U. S. A.

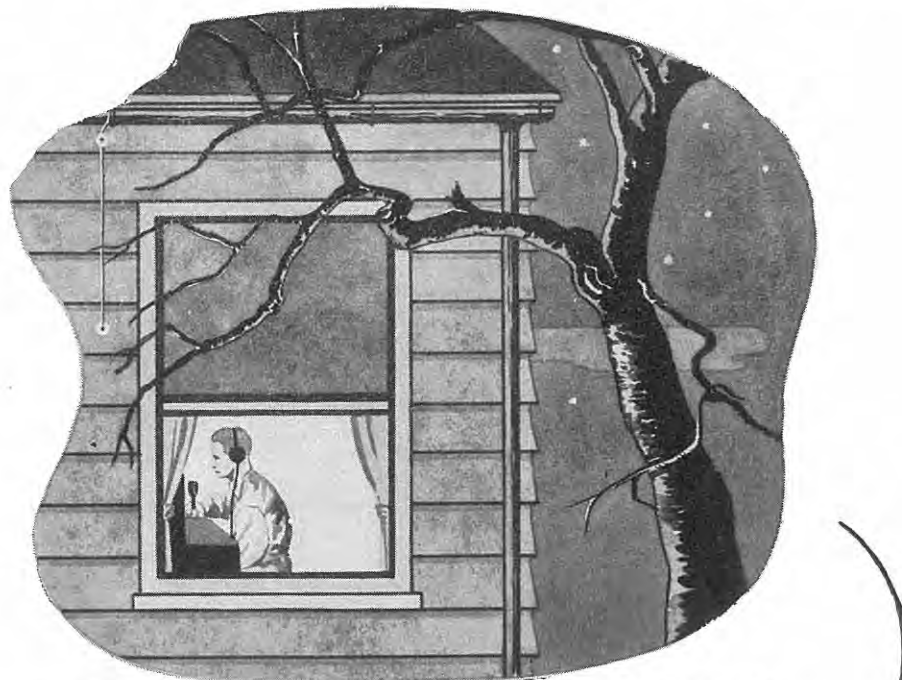

LIKE OLD TIMES

It's great to welcome Canada's radio amateurs back to the air again. This troubled old world needs the unique international friendships which they make with their fellow enthusiasts in many lands.

Canada owes a real debt to her radio amateurs, not only for their pre-war pioneering but for their wartime contribution both in the Services and in specialized work; their technical knowledge proved invaluable in a struggle which annihilated our old ideas of space and time.

NOW AVAILABLE

Marconi RVC Radiotrons, the popular favourite of Canada's "Hams" now include many new types as a result of wartime research and development.

Marconi Crystals and Holders. Crystals now cut, ground and mounted in our own crystal laboratory; the same high quality crystals as supplied by Marconi to the Canadian and Allied Governments.

Transformers, coils, National receivers and General Radio equipment and parts.

CANADIAN MARCONI COMPANY

Established 1903

MARCONI BUILDING, MONTREAL

Vancouver, Winnipeg, Toronto, Halifax, St. John's, Nfld.

XTAL

VOL. 6

NO. 4

DECEMBER

1945

OFFICIAL PUBLICATION
of
CANADIAN AMATEUR RADIO
Published by
THE CANADIAN AMATEUR RADIO OPERATORS'
ASSOCIATION

CONTENTS

	Page
Editorial	8
Renewing Licenses	8
Antenna Coupling Circuit Design.....	9
Report from the Nation	16
Q-Meter, Part III	20
Club Activities	26
Resonant Lines, Part II.....	30
Letters to the Editor.....	38
VE Time	36

INDEX TO ADVERTISERS

	Page
Aerovox Canada Limited	39
Alpha Aracon Radio Co. Ltd.....	42
Bliley Electric Company.....	4
K. Blevis Laboratories.....	23
Canadian Electrical Supply Co. Ltd.....	29
Canadian General Electric Co. Ltd.....	44
Canadian Marconi Company.....	6
Canadian Westinghouse Co. Ltd.....	41
Cannon Electric Co. Ltd.....	3
Crystal Products Company.....	25
Dymac Incorporated	33
Erie Resistor Canada Limited.....	37
T. S. Farley Limited.....	33
Frank Gerry & Co. Ltd.....	27
The Hallicrafters Company.....	43
Hammond Manufacturing Company.....	2
International Resistance Co. Ltd.....	17
Langford Radio Company.....	23
Marsland Engineering Company.....	23
Measurement Engineering	25
Radio Mfg. Engineers Inc.....	5
Stark Electronic Instrument Ltd.....	29
Taylor Tubes Incorporated.....	35
Tube Committee	19
Wholesale Radio Co. Limited.....	31

ADDRESS ALL COMMUNICATIONS
TO

THE CANADIAN AMATEUR RADIO OPERATORS' ASSOCIATION
LEASIDE, P.O., ONTARIO



XTAL'S COVER

Recording Hamdom's return to normalcy XTAL sent photog. 3QK afield to capture some old-timer in typical action—The OT is 3WX. The QRA is London, Ontario—Of course we added the

SEASON'S GREETINGS

XTAL CONTROL

Managing Director
S. B. TRAINER JR., VE3GT

Editor-in-chief
T. G. E. POWELL, VE3ZE

Feature Editor
J. V. PERDUE, VE3QK

Advertising Manager
A. H. GILLIER, VE3AZI

Business Manager
P. POSNIKOFF, VE4ATR

OFFICERS

President
T. G. E. POWELL, VE3ZE

Vice-pres.
S. B. TRAINER JR., VE3GT

Asst. Sect.
L. HORSFALL, VE3AOS

Treasurer
E. BARTMANN, VE3VD

Special Representatives:
T. S. CARPENTER, VE3BD

F. M. HAINES, VE5MQ

Secretary
I. H. NIXON, VE3ACL

EDITORIAL

So sorry . . . but, from a couple of weeks of being on the air . . . on ten . . . we are forced to mention a thing or two. First of all, dummy antennae are easy to construct and use. It's no fun having a QSO, and they're rare enough, and just getting along fine when someone nearby . . . or farby . . . swoops back and forth across the listening frequency, and likely perches finally a few kc away. It's even worse when the signals are unclear, ripply and full of parasitics. On the air doesn't seem to us the place to hear parasitics every 200 kc or so. It doesn't seem the place, either, to be asked "What's my frequency?" particularly when that old crystal was once a band-edge one. "RF feed-back" or "how's my ripple?" should be taboo. Sure, we're all anxious to be back on . . . and those of us that have temporary rigs. . . . but let's keep them and the air clean. We're certain the RI isn't going to stand for monkey business . . . and some of us'll find out one of these days when we get a suspension.

So, how about it, fellows? We are only annoying one another now, but when we get the other bands we're international. Let's keep the VE signals and operators of a high standard.

After the blast and as the remaining grains of sand trickle to the base of the Year Glass, we find ourselves reflecting in the spirit of Christmas past. After the tree was decorated, the stockings filled, and all through the house not a creature was stirring; with slippers on and lighted pipe, we sat down to the soft light of the rig with the aura of warmth and goodwill in our hearts. Most of us, and possibly all of us, have had this sensation. We think it is a very special sensation, one which can only be sensed by radio operators. It has been seven long years since a turn of the magic knob drifted us out into the glow of this spirit of fraternalism, and from somewhere out there the speed of thought clipped through the air lanes, down through the Milky Way and into a point on your dial with a "Merry Xmas OM." Doesn't it warm the cockles of your heart to think about it? Haven't you sat there entirely pleased with mankind. It seems to us that there are very few other forms of diversion quite as soul satisfying as Amateur Radio. Especially at Christmastime. . . .

RENEWING LICENCES

Inserts were sent out with most copies of the last issue of XTAL. They contained the latest information regarding pertinent amateur rules and regulations. However, to go further, in order that permission be granted either by the department at Ottawa, or the divisional radio inspector, it is necessary that the following questions be answered in full:

1. Amateur Experimental Station ofall names in full.
2. Call sign.
3. Date of sending in information.
4. Postal Address.
5. Licence Number.
6. Certificate of Proficiency Number, or Commercial number
7. Exact location of station at present. (Street and house, or lot, section or concession).
8. Exact location of station previously.
9. General description of receiving apparatus, i.e., make and model, types of tubes, circuit, etc.
10. General description of transmitting apparatus, i.e., make and model, types of tubes, circuit, type of oscillation control, etc.
11. System of modulation, if any.
12. Maximum carrier input to antenna.
13. Means provided to measure station frequencies.
14. Means provided to measure modulation, if phone used.
15. Frequency bands to be used, and types of emission on each band (Special endorsement is required for use of phone on 28 mc.)
16. Type of emission to be used.
17. Local telephone number.
18. Source of power for filaments and for plates.
19. Will station be in active operation?
20. Anything else of interest.

It is suggested that a form be made up showing the questions and answers.

Fees are not required to be sent when a station licence was held in September, 1939. Fees should accompany new applications, however. When an amateur resides in a different section a new call must be obtained from the department at Ottawa to correspond to the section in which the station will now operate.

Antenna Coupling Circuit Design

By J. C. R. PUNCHARD, VE2KK*

Every operator is interested in obtaining the highest efficiency of power transfer between his final power amplifier tube and the antenna. Unfortunately, the basic principles underlying radio frequency coupling networks are not generally understood, with the result that many coupling circuits are not properly adjusted. Seriously minded hams can save themselves many hours of experimental work and obtain the best possible efficiency in their rigs by understanding the operation of their circuits and by applying a few shortcuts and simple mathematics to the problem. This series of articles will illustrate the design of L, pi and inductively coupled networks.

Tank Circuit Theory

The power amplifier tube is normally loaded by means of a parallel resonant circuit consisting of a coil and a condenser. The impedance across this type of circuit increases as resonance is approached and becomes a maximum at resonance. At resonance the inductive reactance of the coil ($2\pi fL$) is approximately equal to the capacitive reactance of the condenser ($\frac{1}{2\pi fC}$) and the parallel impedance is a pure resistance. Therefore at resonance the tube effectively works into a pure resistance load, the value of which depends on the L/C ratio and the amount of R.F. resistance in the tank circuit. This R.F. resistance is the sum of the R.F. resistance of the tank coil and the effective R.F. resistance introduced into the circuit by means of inductive or capacitive coupling to the antenna or transmission line. The impedance presented to the tube at resonance is

$$RL = \frac{L \text{ ohms}}{RtC} \quad (1)$$

Where L=Inductance of tank coil in henries

C=Capacity of tank condenser in farads

Rt=Rc + Rx where

Rc=R.F. resistance of coil—ohms

Rx=R.F. resistance introduced—ohms.

The effective series resistance of a well-insulated variable condenser is negligible and does not enter into the problem. Note from equation (1) that for fixed values of L and C, RL varies inversely as Rt. In other words, as Rt increases, RL decreases and vice versa. This relationship is important and is well worth remembering, since it explains the behaviour of the P.A. plate circuit meter during tuning.

The ratio between the reactance of the coil and its R.F. resistance is called the **Qc of the coil**, whereas the ratio between the reactance of the coil and the total R.F. resistance in the circuit is called the **Qt of the circuit**.

$$\text{Thus } Qc = \frac{2\pi fL}{Rc} \text{ and } Qt = \frac{2\pi fL}{Rt}$$

Average Qc's for coils of good electrical design run from about 200 to 400. With very careful design, values up to 500 may be obtained. Values of Qt (sometimes called the loaded Q of the circuit) vary from about 6 to 25, depending on the required operating conditions.

When the antenna load is coupled into the tank by means of coil taps or an inductance loop, we are in effect introducing R.F. resistance in series with the Rc of the tank coil. The power actually transferred to the antenna is the amount of power which would be dissipated by the normal tank circulating current flowing through this introduced resistance. The losses in the circuit are caused by the tank circulating current flowing through the R.F. resistance of the coil.

From the foregoing we realize that to efficiently match the plate of the power amplifier to the antenna, the following conditions must be satisfied: 1—Circuit must be tuned to resonance at the operating frequency. 2—The current amount of resistance must be coupled into the tank circuit. 3—The L/C ratio must be such that the coupled resistance, plus the coil resistance, makes the parallel resistance of the tank equal to the nominal dynamic load impedance required by the tube to develop its rated power output and R.F. plate voltage. (Equation (1)).

Let us examine just what happens when the tank circuit of an inductively coupled amplifier is tuned under rated

*VE2KK, 99 King's Road, Valois, Que.

conditions of constant D.C. bias and drive. At first our tank is not in tune, and the impedance across it is reactive and very low in value. The D.C. plate current through the tube will be high and there will be no appreciable R.F. voltage across the coil. The efficiency of the amplifier will be zero or nearly zero because most of the plate input power will be dissipated in heating the plate, and the R.F. output will be approximately zero. As the variable condenser is rotated, its reactance either increases or decreases. If it is turned toward the position where its reactance will equal the reactance of the coil, resonance will be approached. The load impedance will begin to rise, becoming more resistive and less reactive and the R.F. resistance across it will increase. The rising load impedance will cause the D.C. plate current to fall. Some of the plate power input will be heating the plate and the remainder will be transferred to the antenna. We normally tune the tank condenser until the D.C. plate current meter indicates a minimum dip, which indicates the point of maximum parallel tank impedance. For any given set of component values, it indicates the point at which the tube is developing maximum voltage across its load circuit, delivering maximum power to the tank, hence to the antenna circuit.

But the load impedance at this point may not be suitable for the tube and the desired performance will not be obtained. If the minimum dip plate current is lower than the manufacturer's rating, the load impedance is too high. In this case we must couple in more resistance to the tank circuit. This is done by increasing the mutual inductance between the tank coil and the antenna coil, or as hams say, the coupling is tightened, and the condenser is returned for minimum dip. If the original plate current at minimum dip is too high, the load impedance is too low and too much resistance is being introduced into the tank. The coupling is therefore backed off, thus reducing R_t , and the condenser is returned for minimum dip plate current and a lower value of R_L . This process is repeated until the exact rated plate current is obtained at resonance. The tube is then operating into its rated load impedance and power is being efficiently transferred to the antenna circuit.

Before we can calculate the required values of L and C we must know the dynamic load impedance R_L required by the tube and the amount of resistance we need to introduce into the tank.

Dynamic Load Impedance — The determination of the correct load impedance for optimum performance of an R.F. power amplifier is a rather involved process if the exact point-by-point method of analysis is used. However, for practical purposes it is possible to quickly approximate the required impedance, this approximation being accurate enough for ham use, and, for that matter, for most commercial design problems. This dynamic load impedance is a function of the R.F. voltage which can be developed across the tank circuit and the amount of power required from the tube. Within practical limits, both of these quantities can vary widely for a given tube.

From the manufacturer's tube characteristic data, we select the recommended D.C. plate voltage and the corresponding nominal carrier power output of the tube for the type of amplifier operation required. Normally this data is given for Class C C.W., Class C Grid Modulated, Class C Plate Modulated and Class B Linear Amplifiers. Since the impedance across the tank circuit is a pure resistance at resonance, and the power output of the tube is developed across the tank by virtue of the R.F. plate voltage acting on this pure resistance, we can write, by Ohm's law,

$$W_0 = \frac{(E_{ac})^2}{R_L} \text{ or } R_L = \frac{(E_{ac})^2}{W_0} \quad (2)$$

Where W_0 = Output of tube in watts
 E_{ac} = R.M.S. R.F. plate voltage across tank in volts
 R_L = Dynamic load impedance ohms.

The R.F. plate voltage swings symmetrically above and below the D.C. plate voltage value. Its maximum peak value can never exceed approximately 80% of the D.C. plate voltage without serious distortion of the R.F. waveform and excessive grid current. As the instantaneous grid driving voltage is increased in a positive direction, the instantaneous R.F. plate current increases, causing the instantaneous R.F. voltage at the plate of the tube to fall. It is therefore possible to drive the grid more positive than the plate. If this

happens, the grid draws off a higher than normal percentage of the total electron emission from the cathode and the plate is left with a deficiency of electrons. This accounts for the rapid rise in grid current as the grid is driven into the positive region, and also for plate distortion which occurs under this condition. In triodes, plate and grid voltage are usually nearly equal at about 20-25% of the D.C. plate supply voltage. In tetrodes and pentodes, the instantaneous plate voltage must never be allowed to drop below the voltage impressed on the screen or beam-forming plates. The actual point at which grid and plate voltage are equal depends on many factors, including fixed and variable bias voltages, grid driving voltage, grid and plate operating angle, load impedance, D.C. plate voltage, etc., but the above approximations are sufficiently accurate for all practical purposes.

For Class C telegraph operation, which allows the maximum rated power output from a tube, the peak value of the R.F. plate voltage is therefore $E_{dc} (1-0.2) = 0.8 E_{dc}$, where E_{dc} is the plate supply voltage. The R.M.S. R.F. plate voltage is therefore

$E_{ac} = 0.707 \times 0.8 E_{dc} = 0.56 E_{dc}$ (3)
 Substituting equation (3) in equation (2) we have

$$R_L = \frac{(E_{ac})^2}{W_0} = \frac{(0.56 E_{dc})^2}{W_0} \text{ ohms} \quad (4)$$

Example: Suppose the rated power output of a tube operated at a plate voltage of 500V as a Class C amplifier is 25 watts for telegraph conditions.

E_{ac} would be $0.56 \times 500 = 280V$

$$R_L = \frac{(280)^2}{25} = 3140 \text{ ohms}$$

For Class B. Linear operation the maximum permissible R.F. plate voltage at 100% modulation is still approximately 0.8 E_{dc} . At 100% modulation, the peak R.F. plate voltage is just twice its value at carrier with no modulation. Therefore with no modulation applied, the idle carrier value of E_{ac} will be

$$\frac{(0.707 \times 0.8)}{2} E_{dc} = 0.28 E_{dc}$$

In the above example if we wished to operate the amplifier for Class B Linear phone, the grid drive would be backed off until the carrier was cut in half. If we used the same load impedance as before, we would expect an output of

$$W_0 = \frac{(0.28 \times 500)^2}{3140} = 6.25 \text{ watts}$$

While this condition would result in good phone operation, somewhat more power can be used. This is obtained by dropping the load impedance (change L/C ratio or increase coupling to increase introduced resistance). In the above case, the manufacturer of the tube would likely find that about 9 watts could be obtained without unreasonable distortion. This would require a load impedance of

$$R_L = \frac{(0.28 \times 500)^2}{9} = 2180 \text{ ohms.}$$

It is interesting to note in passing that the optimum load for telegraph operation is seldom the optimum for phone operation and the L/C ratio of the tank, or coupling, should be readjusted for best performance, if we expect to switch from one type of operation to the other. In actual practice a compromise adjustment is usually obtained between the two types of operation.

The following table shows the approximate values of E_{ac} to use for calculating R_L for various types of amplifiers.

Operation	E_{ac}
Class C Telegraph	0.56 E_{dc}
Class C Plate Modulated	0.56 E_{dc}
Class C Screen and Plate	
Modulated	0.56 E_{dc}
Class B Linear Phone	0.28 E_{dc}
Class C Modulated	0.28 E_{dc}

In each case E_{dc} is the manufacturer's recommended value of plate supply voltage for the particular type of operation.

Design of L Network — In this discussion we wish to establish simple methods of design for inductively coupled tanks, pi networks and L networks. The inductive type of circuit is most easily designed by first assuming a reasonable value of Q_t , whereas the latter two networks are most easily solved by thinking of them as impedance transformers between the plate of the amplifier tube and the antenna circuit.

The simplest, yet perhaps least known of the coupling circuits for use below 15 Mc is the L network, consisting of a series inductance L and a shunt condenser C shown in Fig. 1 (a).

This circuit has been widely used in portable military and aircraft transmitters because of its simplicity and the wide range of impedance loads it can accommodate. It will be recognized at once that the antenna has been included directly in the tank circuit, Fig. 1 (b).

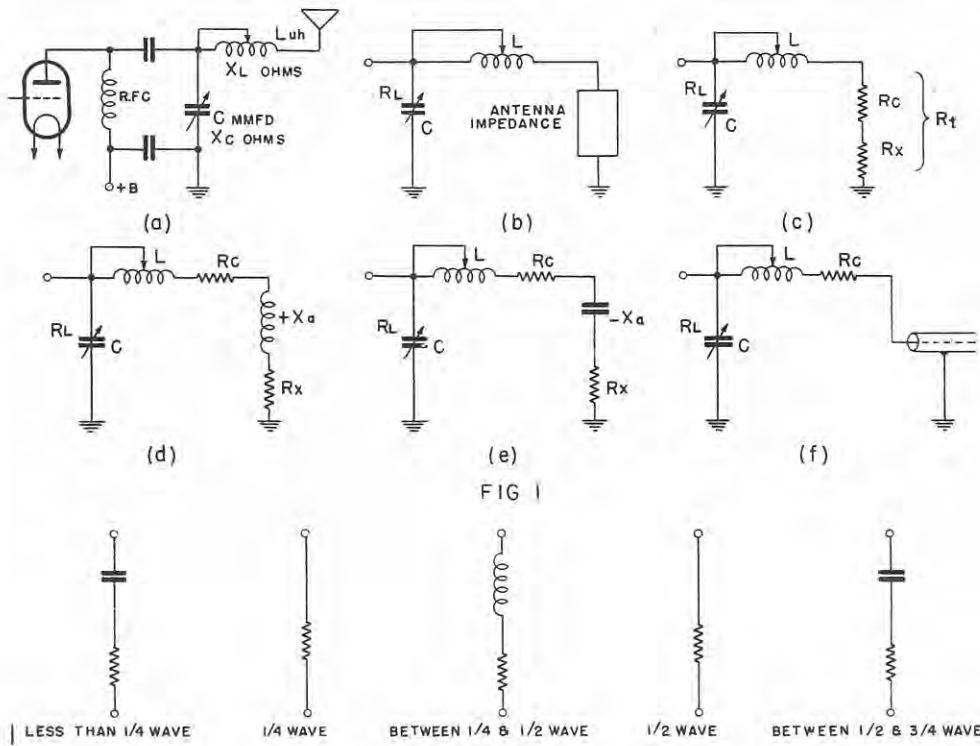

FIG 1

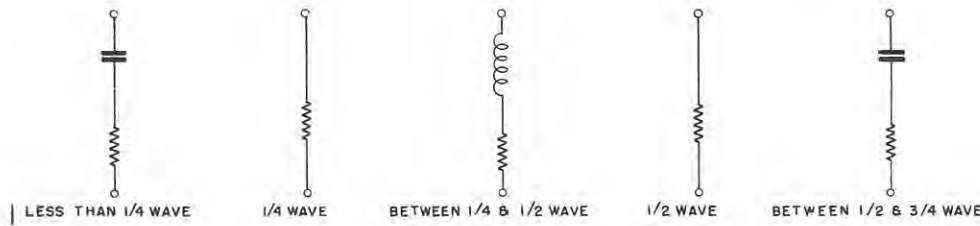

FIG 2

Therefore, harmonics which appear in the tank circuit will be radiated from the antenna. This is an undesirable quality for high-powered equipment, and this circuit is suitable only for low-power transmitters where harmonic suppression is of secondary consideration. It is ideal for portable ham rigs because it can match almost any reasonable length of single-wire antenna which can be erected.

Most ham antennas are operated at resonant modes, in which case their lengths are $\frac{1}{4}$, $\frac{1}{2}$ or $\frac{3}{4}$ wavelengths. By using the L network, it is not necessary to cut the antenna to a particular length. Any length of antenna between 0.1 and 0.5 wavelength can be easily and efficiently matched.

Obviously, to design for a perfect match between antenna and tube, the correct values of L and C must be found. To find these quantities we must first know something about the antenna impedance. A single-wire antenna has a certain base impedance depending on its

length and frequency. It behaves like a resistor in series with either inductance or capacity. Figure 2 shows the nature of the impedance of a vertical or sloped wire or tower, referred to electrical length.

For quick reference, the variation of the base terminal impedance of a vertical or slightly sloped wire has been plotted against physical height in fractions of a wavelength in Fig. 3. The height of the antenna in wavelengths is found from

$$h = \frac{\text{Length of Ant. in feet} \times \text{Freq. in Kc} (5)}{984000}$$

The curves in Fig. 3 are drawn as bands to represent average values measured on actual towers and vertical wires. The actual impedance of a particular antenna will be affected by its proximity to other objects, its base capacity and the ground conductivity, but Fig. 3 will give a value accurate enough for design purposes. Note that the points at which reactance is zero do not coincide exactly with the quarter-wave points. This is

due to the fact that the speed of transmission of R.F. along the antenna is less than that of light. Normally it can be assumed to be about 95%, so that the physical length of an antenna is about 95% of its electrical length.

As an example of the use of Fig. 3, suppose a 50-foot vertical pipe antenna is to be operated at 7200 Kc. What are its impedance characteristics?

$$\text{Its physical length} = \frac{50 \times 7200}{984000} = 0.366 \text{ wavelengths}$$

From Fig. 3, its resistance would be approximately 180 ohms and its reactance about 140 ohms positive or inductive.

The complete solution for the L network is shown in Fig. 4. Knowing R_t and R_L , the two impedances to be matched, we find the value of X_c in ohms from the left-hand section, and hence its value in micromicrofarads. The value of L in microhenries is found from the right-hand section. Proceed as follows: Beginning at left-hand ordinate follow the value of R_t until it intersects the required sloping RL line. Read X_c in ohms on the abscissa or follow this vertical line until it intercepts the dotted frequency line required. Follow the horizontal line to the left and read capacity on the ordinate.

Example: Suppose required $R_L=2000$ ohms and $R_t=20$ ohms. These two values intersect at $X_c=200$ ohms. If we are working at 7 Mc, this would require 114 micromicrofarads from curves. Find L in microhenries in a similar manner. If these values of C and L are set up in this circuit and the operating voltages on the amplifier are correct, the circuit will be tuned to resonance at 7 Mc, and the 20-ohm load will present an impedance of 2000 ohms to the tube and optimum performance will result.

If the antenna is cut so that its length is 0.23 or 0.45 wavelengths, its reactance will be zero or negligible in value and it will be mainly resistive as shown in Fig. 1 (c). The following steps are then required to design the network.

- Procedure No. 1—
1. Calculate Eac from previous table.
 2. Calculate R_L from equation (4).
 3. From Fig. 3 find antenna resistance, which is R_x in this case.
 4. Assume R_c about 2 ohms and calculate $R_t=R_c+R_x$.
 5. Find values of C in mmfds. and L in microhenries from Fig. 4.

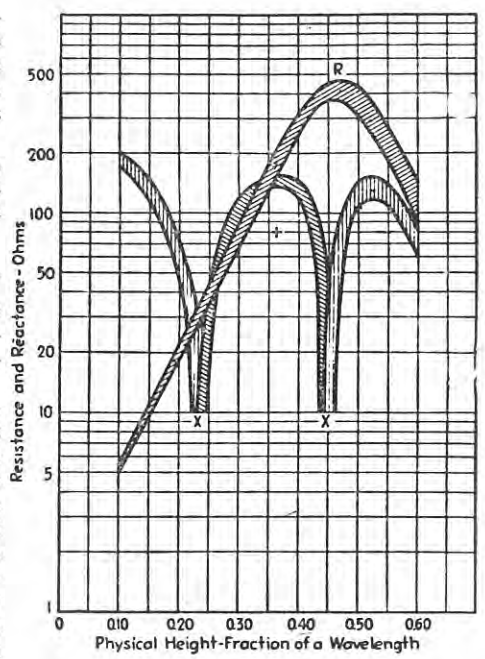

Fig. 3

When the antenna has both resistance and reactance, the tank coil has two functions to perform. Part of it, as determined from Fig. 4, resonates with the condenser C at the operating frequency. The other part cancels the reactance of the antenna. When the antenna reactance is negative, positive reactance of an equal value must be added to L to bring the entire tank, which includes the antenna, to resonance. When the antenna reactance is positive, less reactance, by an equal amount, is required in the tank coil, because the reactance in the antenna acts just as if it were in the coil itself.

Where the antenna has positive reactance, Fig. 1 (d), proceed as follows: Procedure No. 2—

1. Follow steps 1 and 2 in procedure No. 1.
2. Find physical length of antenna from equation (5).
3. From Fig. 3 find positive antenna reactance (X_a). Note that this reactance is in effect part of the total tank coil reactance required.
4. For given R_L and R_t find C in mmfds. and reactance of L in ohms for resonance (XL) from Fig. 4.

5. The reactance of the tank coil required is then $X_t = XL - X_a$.
6. Find value of L in microhenries from Fig. 4 equivalent to reactance X_t .

Step 4 shows that this circuit will match any value of antenna reactance X_a up until $X_a = XL$ at which point $X_t = 0$. In other words, the tank coil disappears entirely and we use the antenna as the coil.

Where the antenna has negative reactance, Fig. 1 (e), proceed as follows: Procedure No. 3—

1. Follow steps 1 and 2 in procedure No. 1.
2. Find physical length of antenna from equation (5).
3. From Fig. 3 find negative antenna reactance (X_a). Note that this reactance must be added to the reactance of tank coil, i.e., a larger tank coil will be required to cancel out the antenna reactance.
4. For given RL and R_t find C in mmfds. and reactance of L in ohms for resonance (XL) from Fig. 4.
5. The reactance of tank coil required is $X_t = XL + X_a$.
6. Find value of L in microhenries from Fig. 4 equivalent to reactance X_t .

The L network may be used for matching directly into a coaxial transmission line Fig. 1 (f), in which case R_x will be coaxial. This value will be 50 to 70 ohms and if properly terminated at the antenna end the reactance looking into the line will be zero. Procedure No. 1 is followed in this case.

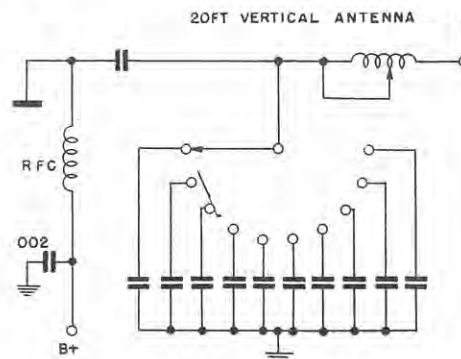

FIG 5

This network is suitable for matching low resistance and high reactance. Antennas less than one-quarter wavelength come into this category. This means that this circuit will match 10 or 15 feet of wire at 7 Mc if the components have the right values. As the value of the load resistance R_t increases, the value of C for matching becomes very small. The limitation is reached when the value of C required is just equal to the stray capacity of the circuit and the variable condenser is no longer required.

Suppose we run through the design of an L network for use on a low-power portable transmitter for 3.5, 7, and 14 Mc bands. We choose for the longest practical antenna a single sloping wire 30 feet long. At 3.5 Mc this would be 0.107 wavelengths long by equation 5. From Fig. 3 its base resistance would be 5.2 ohms and its reactance—185 ohms. The total R_t in the circuit will be approximately $5.2 + 2 = 7$ ohms. If we assume an average load impedance of 2000 ohms for the amplifier (this will vary as explained heretofore) then from left hand section of Fig. 4, X_c is 119 ohms and $C = 390$ mmfds. X_t is found to be 120 ohms for resonance but in addition we must add 185 ohms of coil reactance to cancel the negative antenna reactance. Then $X_t = 120 + 185 = 305$ ohms or $L = 14$ microhenries.

At 7 Mc and 14 Mc the following values are found for this same 30-foot antenna and $R_L = 2000$.

	7 Mc
Length	0.214 wavelengths
Resistance	23 ohms
Reactance	-40 ohms
$R_t = 23 + 2 =$	25 ohms
X_c	222 ohms
C	102 mmfds.
XL	222 ohms
$X_t = 222 + 40$	262 ohms
L	6 microhenries
	14 Mc
Length	0.428 wavelengths
Resistance	370 ohms
Reactance	+80 ohms
R_t	372 ohms
X_c	960 ohms
C	12 mmfds.
XL	780 ohms
X_t	700 ohms
L	8 microhenries

(Continued on page 38)

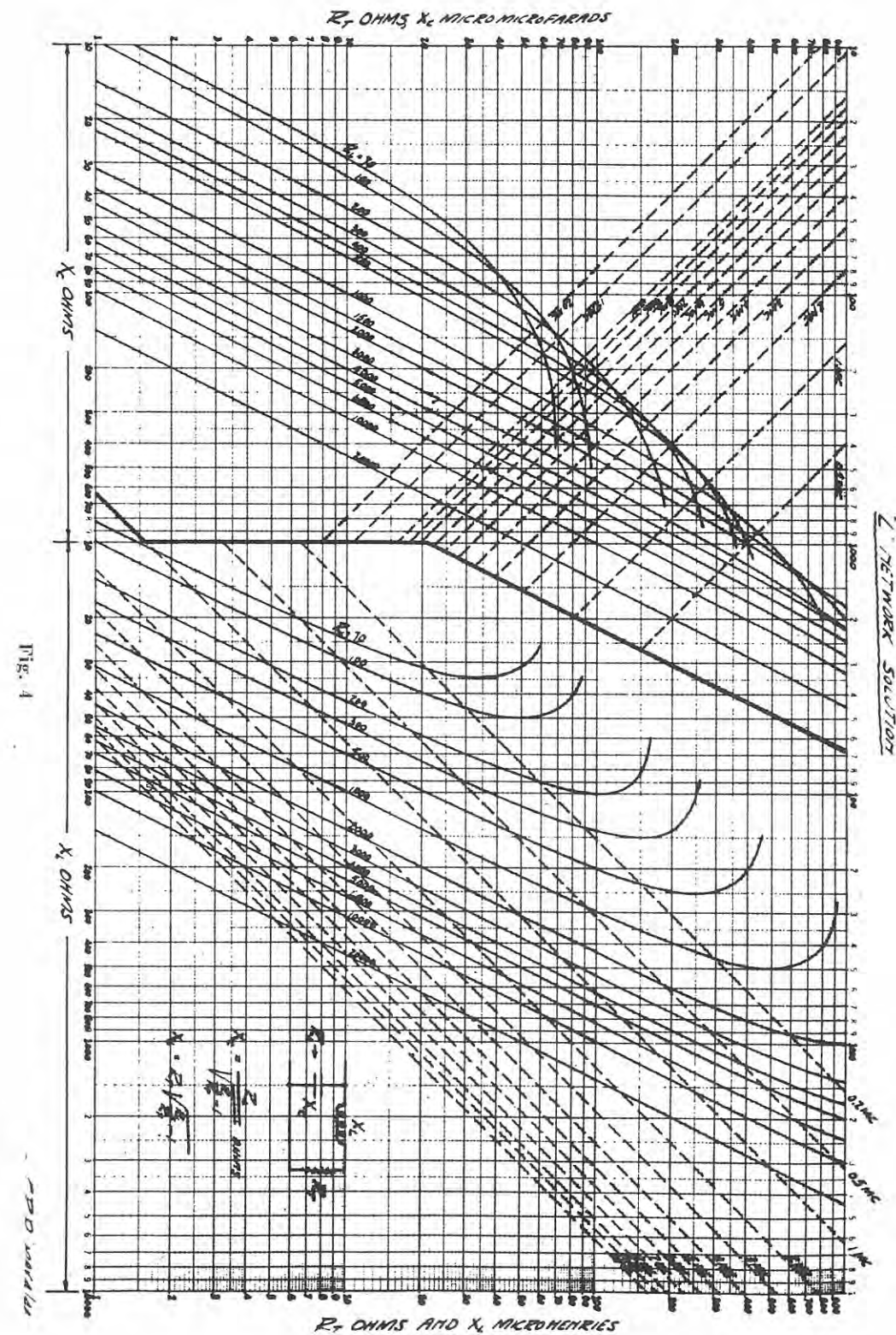

FIG. 4

Report From The Nation

From where we sit, 'midst stacks of letters a full dipole high, it would appear that all God's chillun's want megacycles. The Victoria Short Wave Club said it . . . "we have just given ourselves a shot in the arm and life now flows through us—all 35 who answered the roll call meeting of Oct. 5th waddering ham lingo like the Dutch—plans, plans, plans. 5HR reports for VSWC . . . Mebbe it's a good idea to keep all the 5's, the 4's and the 3's, 2's and 1's together in this report, but the Christmas Spirit has come upon us and we, more now in this year of peace than for the past five, are imbued with the spirit of gathering our chillun's around the fire-side because it's been a long time since we've felt the warm glow of their comradeship. So let's mix, brethren, let's all gather round and join hands TOGETHER . . . Here's 1FI away over in Varel, Germany, with Sigs, who sez that it's just swell to hear from you guys again thru XTAL . . . (Gosh, Sam, XTAL's in D-Land, stick another pin in the map!) . . . 3BU reports for JZ, AWG, 2RA, and also brings Ottawans Tepley, Webster, Meehan, Van Zant and Chambers to our little Xmas Party . . . Welcome . . . six service stripes decorate the operating arm of 1LS aching to go again—Navy lad . . . Merchant Navyman Bill Corbett comes forth with newsy chat and wants to get his call, but soon . . . Swell letter from 4EM in Saskatoon, met all sorts of hams in D. of T. job, including 4MZ and 4UR and a YL who signs 4FL, all in Sovereign, Sask. . . . 4XY and 4MN are still in the Navy . . . 3AON wants some 112 mc and higher gen . . . definitely yes, PB . . . we nearly passed 1KN's letter to the treasurer, it was on one of his business statements! . . . tnx Dick . . . O. C. Boettger sez that the Kitchener-Waterloo Club is a going concern . . . 3OT in St. Thomas wants to say hello to the Niagara District hams . . . 3ATE drops us a dandy chit with a chat about how he and 3ATD worked parallel with TCommand from Newfie all the way to the jungles of Nassau and back . . . and ATD can sit on his frequency again under which is . . . ATE, of course! . . . and only 5 doors away . . . Val tells

3AGB to cheer up cuz there's mail on the next dog sleigh . . . (remember AGB's plea for mail . . . from the Yukon . . . that's the spirit of Xmas) . . . before we forget, you'll find his QRA in Oct.-Nov. issue of XTAL, "Letters to the Editor" . . . from U. of N.B. comes 1JX with 73 . . . 2BV and 2MX are immediate buddies of 3PI at RCA, Montreal . . . 1HO finds himself mixed up with the London gang . . . and wot a mix-up! . . . if you get what we mean, and we think you do! . . . of course he wants 3rd District call to get going again . . . what fun . . . gosh, I haven't written this kind of a column since I was SCM . . . yessir . . . way back in '36 . . . let's see, who's that guy over there, behind the specs . . . ole Pip himself . . . 3DU to you, TL expert, DX expert, 28 meggie expert, hush-hush expert . . . good to see you back, Dave . . . and 3SV, who has been away at sea and in the Arctic service . . . good to hear from 1CN again . . . and Bob Rennie, the Agincourt Kid, is still fighting on the beaches of the Rideau at Ottawa . . . 3IR, we mean . . . and speaking of beaches, 5CS pens his war history from Penticton, B.C., to say that he was on "that beach" D-Day and all the way up through the Northwest European campaign . . . he met PA0YN in Holland and had a real gabfest with SP2HH in London . . . 3ALE enjoys AAN's bedside manner while recuperating from recent illness . . . 5AHV joins the fun from Fernie, B.C. . . . 3AAG has been in the Land of the Rhumba for the past three years and has bet with 3CD, also back from South America, to see who works the first South American . . . also sez congrats on FB covers XTAL gets from her camera . . . FIENDS (charge that last invective to my colleague GT) . . . 1DR of WAC fame is anxious to burn the midnight oil again . . . 3MW is in biz for himself now and welcomes the push to get going . . . 3AJE in London makes us chuckle with dandy letter with the lowdown on the Forest City gang . . . f'r instance, AQJ had big birthday party . . . and he means BIG . . . at which was AQK along with his recollections of India . . . ask him sometime! . . . and then run for the nearest shelter . . . 3XO was there too, com-



A CHAT WITH XTAL READERS . . .

No. 4 of a Series

The three preceding articles in this series have dealt with IRC type BT Metallized Resistors. Now we are going to tell you something about the Type F Metallized Resistors, built for high frequency performance.

They are unequalled for certain types of applications, particularly where special mounting and terminal facilities are required or for high frequency requirements.

The F type resistors are made in five wattages: 1/3, 1/2, 1, 2 and 3 and are available in a number of mounting arrangements. The famous moulded contact joining resistance element and terminal in a solid casting of metal accounts for the extremely low noise level of these resistors. The famous Metallized filament offers stability, negligible voltage coefficient and freedom from serious changes in resistance value under abnormal conditions.

The Metallized resistors are non-inductive. This is particularly true of the F type, and IRC recommends its use for all high frequency applications. Many engineers, throughout the electronic field, have found that at extremely high frequencies the Metallized resistor is by far the most satisfactory unit for exacting requirements, such as superheterodyne oscillator circuits, AVC filter circuits or as grid leaks across r.f. tubes.

Grid leak type conical end resistors, resistors with terminal lugs, and the famous center mould gang mounting arrangement are available.

In our next article we will tell you something about Ultra-High Range Glass Enclosed Metallized Resistors. These are known as IRC type FH and MG.

INTERNATIONAL RESISTANCE CO.
LIMITED
11 King St. West, Toronto

plete with new XYL and jr Op. . . . quite a shindig . . . ACO and DU, escorted by AJE, show W6CRT ex-K6CRT the town every few weeks . . . he is getting to know it by now pretty well . . . at least certain parts of it . . . and whaddya know . . . Hollywood hasn't ALL the pretty gals, cuz 6CRT found his'n in London and up and got hitched! . . . VE scores again . . . 3HI is back from Aussieland and is raring to go . . . 3JD is still messin' around Barriefield with RCCS . . . and, add hitchin' posts, these London Gals, 1HO got one too! . . . 3ARS of Paris, Ontario, with 3TV, joined up with RCAF in '39 and looks forward to tossing a few CQ's instead of blockbusters . . . 3ADA is back after a four-year stretch overseas . . . at new Leaside QRA . . . 3KD in St. Thomas is really glad to be back on civvy street . . . 3ABJ is away up in The Pas on RR work and has Utopia of revrs to work with come the day . . . 4KJ is torn between the ends of his feeders and a bonspiel . . . we'll betcha feeders get 'im . . . he plugs for low power . . . 4AOH was F/L in AF and is longing to get at brass-pounding again . . . 1KS writes to tell us that his background of ham radio served him well in the service . . . he's a Captain . . . 4AOZ lent his rig to the government for the duration and they have promised to send it back completely overhauled and ready for the OPENING . . . speed the day . . . sez he . . . 1BK from Caledonia Mines in Sydney, N.S., has been soldiering for past six years, now a lieutenant in R.C.E.M.E. and sends 73 to the gang . . . 5DY sends FB report from Victoria on the Victoria Short Wave Club and mentions the thrill of meeting so many hams while on course at St. Hyacinthe . . . there were 2DJ, 3WL, formerly of Windsor and who plans a QSY to VE1 at Halifax, 4AAR, ex-5NA, 5RB, 5DS, 5AIZ, 4BH, 4IC, 4YM, 4MN, 4XY and 5ACA . . . he also furnishes such glad tidings as 5SP, a prisoner of war at Hong Kong, who will spend this Christmas with his family . . . should we remind you why we say THIS Christmas . . . remember Hong Kong . . . 5EP and 5QH will QSO Santa Claus from VK-Land this year . . . 3WF in Owen Sound sends 73 and leads into the fold Lloyd Galbraith . . . a VE3-to-be . . . Welcome, LG . . . Oh, by the way, 5DY wants to own an HRO . . . lives at 1614

Pinewood, Victoria, B.C. . . . 3RQ wants more dope like ex-3ALC's FB articles on Q-Meters and gen such as tube testers, condenser testers, test oscillators, low cost oscilloscopes, etc., etc. . . . meb-be can do, soon . . . keep an eye peeled . . . 3AID in Markham joins the circle . . . Richard Wharton of Waterford needs a 6CSG and encloses membership application for his son who is still with Merchant Navy . . . golly, these Dads are swell guys, aren't they? . . . 5HC, when not selling, thinks of the day of waking . . . another swell Dad is 3HV, up in Smooth Rock Falls, who wants son at St. Hyacinthe in R.C.N.V.R. to have a subscription to that certain lil magazine . . . thanks, Dick . . . and by golly, here's fall guy 5ND out in Vancouver reporting for the B.C.A.R.A. and telling us that Fred Taylor is gonna secretary for them this coming term . . . and right here and now we tarry to shake by the hand 5DU, 5BA, 5BQ, 5EV . . . Doug Sinclair . . . and the following gang from the Totem Amateur Radio Club, 5ES (the dot king), 5ND, 5EN . . . howdy, fellers . . . we like this name—Trans-Canada Communications Ltd. . . . well, anyway, it's CKRM and Cliff Mann is the chief op . . . has a commercial ticket and is CAROA member number ten nineteen and with 4ML plan ham rigs pronto . . . 3AGR is back from the wars and into S.P.S. for a hitch . . . met a lotta hams in England, Belgium and Holland . . . 3EE, another Paris feller, comes forth with nice epistle and welcomes advent of post-war XTAL . . . has been seeing the world with R.C.A.F. for past four years . . . 3RO of Windsor is in Washington, D.C., with the R.N. and expects discharge come Christmas . . . got himself swell little gal while overseas . . . she's from U.S.A. . . . married, of course, now . . . 3WX polishing up rig and worrying about antenna, dog, and the close of golf season . . . 3ANP of Port Arthur is old-timer anxious to shove a key again . . . 3ARY of Welland is greatly appreciative of the man whodunnit . . . plug . . . 3AEE sez XTAL was a pleasant surprise . . . you ain't seen nuthin' yet, Bob . . . 3ALB has been around since '39 . . . seeing plenty of country . . . in one of those distinctive blue suits that fly . . . and calls XTAL "OUR mag" . . . that's the spirit . . . From Sarnia comes nice

(Continued on Page 40)

SPECIAL LOW PRICES ON RADIO TUBES

2X2/879*	.40	RK60*	.90	878	5.00
5AP1	7.65	VR105/30*	.35	955	1.30
54P4	7.65	801A	1.60	956*	1.30
5BP1	7.65	807	.65	CK1006*	.40
5GP1	7.65	812	.65	CK1007*	.40
6AB7*	.40	813	11.00	E1148*	.35
12A6*	.30	826	7.65	1299*	.35
RK39	.65	837	1.70	1616	2.60
EF50*	.35	866/866A	.95	9002	.30
		9006	.30		

* New Releases

See Your Jobber Now!

Through the joint efforts of War Assets Corporation and the undersigned Committee it has been found possible to offer the entire war surplus stocks of transmitting and cathode-ray type tubes, through the regular distribution channels, at the foregoing substantially reduced prices. The tubes are guaranteed operable at published ratings, and the prices will remain in effect as long as stocks last.

Manufacturers Radio Tube Committee

Formed at the request of the Department of Munitions and Supply, now sole disposal agency on radio tubes for War Assets Corporation.

Canadian Westinghouse Co. Ltd.

Northern Electric Co.

Canadian Marconi Co.

Rogers Electronic Tubes Ltd.

Canadian General Electric
Co. Ltd.

Q-METER - - Part III

By G. A. Richards, ex-VE3ALC*

The plug-in "standard" coil and condenser units described in Part II of this article are of little value until their properties have been accurately established by careful measurements. The output capacity of the test terminals must also be found. Obviously it is impossible to measure these quantities without reference to some precision standards, but the whole procedure may easily be carried out without necessarily bringing the Q-meter and some high quality commercial instrument together on the same bench.

The first quantity we should measure is the output capacity of the test terminals (and the associated circuit con-

is! If it is not nearby, the mica condenser is easy to ship by mail).

Calling the capacity of the mica condenser C (mmf.) and the distributed capacity of the choke Cd, we then have the output capacity, Co from:

$$C_0 = \frac{C}{\left(\frac{f_1}{f_2}\right)^2 - 1} - C_d$$

Where F_1 is resonant frequency with coil alone across terminals.

Where F_2 is resonant frequency with mica condenser added.

If we have chosen the r.f. choke as specified above, then $C_d=1$ mmf. in the

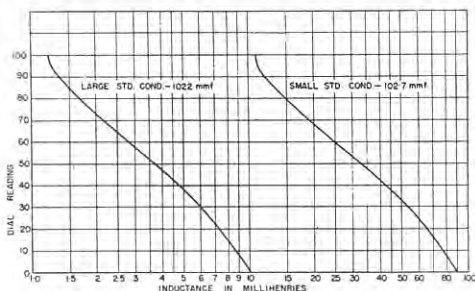

FIG 1 - EFFECTIVE INDUCTANCE vs DIAL READING BAND 1.

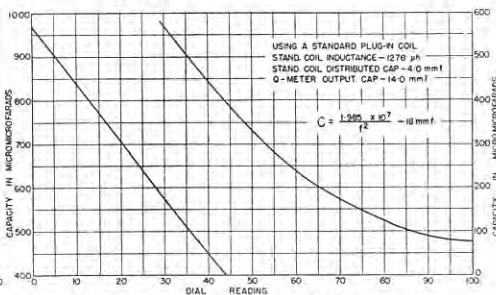

FIG 2 - CAPACITY vs DIAL READING BAND 2

nected thereto). This may be done indirectly, but nevertheless with considerable accuracy as follows:

First, secure one of those pi-wound 1-1/4 or 2-1/2 mh. r.f. chokes advertised as having a distributed capacity of 1 mmf. It is doubtful that this figure will be in error by more than fifty per cent, i.e. $\pm .5$ mmf. This will be the main limitation to the accuracy of the test. Next we insert this choke in the test terminals and check its resonant frequency first with no external tuning capacity, and then shunted by a high quality mica condenser of 100 to 500 mmf. capacity. Then we submit this latter condenser to a laboratory equipped for accurate measurement of such values. (Usually we will be associated either directly or indirectly with such laboratory, or else we will know some one who *149 Sidney St., Cambridge, Mass.

above formula. In the writer's instrument C_0 , thus measured, was 14.0 mmf.

From this point on, knowing the output capacity of the unit, and having an accurately measured mica condenser on hand, it is theoretically possible to complete the standardization procedure for the plug-in coil and condenser units without further reference to a commercial laboratory instrument. This procedure is not recommended, however, because (1) it involves one extra measurement error, namely that involved in the measurement of the output capacity and the auxiliary mica condenser; and (2) the instrument is truly capable of a high degree of resolving power; and this should be taken full advantage of, by achieving the greatest possible accuracy in the standardizing process. It is therefore recommended that the plug-in standards be measured on the best equipment

available, at several frequencies, and the results of several measurements averaged to obtain the final figures. A substitution method, using a variable condenser is probably the best for standardizing the plug-in condensers. The coil should be checked if possible on a commercial Q-meter. Its distributed capacity should be checked by first noting its resonant frequency with the minimum possible tuning capacity. This we will call F_1 , and the capacity C_1 . Then capacity should be added until the frequency is exactly one-half of F_1 . The total tuning capacity is now C_2 . Then, the unknown distributed capacity is:

$$C_d = \frac{C_2 - 4C_1}{3}$$

When mounted, the writer's standard coil had a C_d of 4.0 mmf.

The coil inductance should then be measured by checking its resonant frequency in a reliable test instrument with known values of external capacity. Its (true) inductance will then be:

$$L = \frac{25.33 \times 10^9}{f^2(C+C_d)} \text{ microhenries}$$

Where C is the external tuning capacity in mmf.

C_d is the distributed coil capacity in mmf.

f is resonant frequency in kc./s.

As before, several different measurements should be made, and the results averaged to obtain the final figure.

Practical Operating Procedures:

The generalized "Method of Operation" described in Part I of this article can now be enlarged upon, and some practical short-cuts added. The measurement of the Q of a tuned circuit scarcely needs further elaboration. It should be pointed out though, that the dynamic plate resistance of the 6AC7 is always shunting the tuned circuit, and when the latter has a high impedance, this may cause an appreciable error. (The impedance of a tuned circuit at resonance is equal to the reactance of either the coil or the condenser, multiplied by the Q.) This shunting effect will be most apparent at the lower frequencies, since the reactance of the plug-in condenser used for the measurements will become greater. To gain some idea of the magnitude of the errors arising from this source, the use of a 1,000 mmf. condenser to resonate a coil a Q of 100 would lower the Q reading by a 10%

error, at a frequency of approx. 200 mc.; assuming the output resistance of the Q Meter to be 750,000 ohms,—a reasonable estimate. This error would vary inversely with frequency (5% at 400 kc., 20% at 100 kc.) and directly with Q (5% with Q of 50; 20% with Q of 200). If the tuning capacity had a value of 100 mmf. instead of 1,000 mmf. then the 10% error for a Q of 100 would occur at a frequency of 2 mc. A worthwhile precaution, where accurate Q measurements are desired, is to operate at a reduced r.f. voltage level, by turning the slideback voltage control no more than half way up; and thus avoid operation below the knee of the 6AC7 plate characteristic, which would cause a reduction in dynamic plate resistance. In most practical cases we are interested in comparative Q measurements and the above precautions can then be ignored.

For the measurement of unknown inductances or capacities it is convenient to prepare curves of the equations (2) and (3) of Part I. To do this we insert the now known values of capacity, inductance, distributed capacity, output capacity, etc. in the equations, and calculate the resonant frequencies for a series of values of L_x and C_x . To make

**PLEASE TURN OVER
For
APPLICATION FORM**

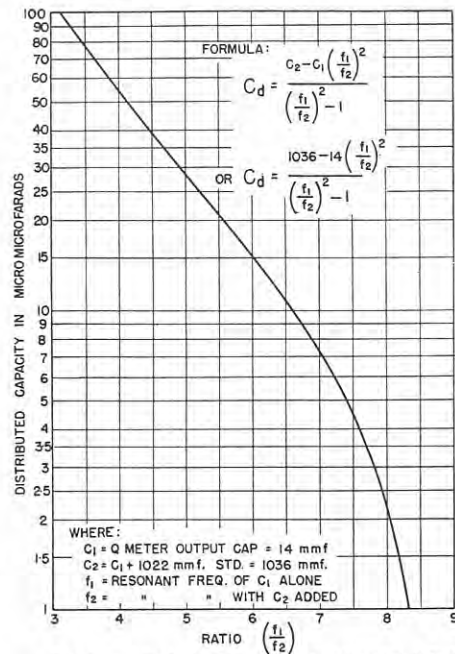

FIG. 3. - MEASUREMENT OF DIST. CAP. OF COIL

the curves still more useful the calculated frequencies can then be converted to dial readings (from the previously prepared frequency calibration curves) and the results drawn up as curves of Lx and Cx vs. Dial Reading for each band, and for each plug-in standard. Typical inductance and capacity curves are shown in Figs. 1 and 2 respectively. Note that the value of C in equation (2) Part I includes the output capacity of the test terminals as well as the capacity of the plug-in condenser. The inductance value obtained from Fig. 1 is the "Effective" and not the "True" inductance. Generally, but not always, the two are nearly enough equal for practical purposes. The true inductance will always be less than the effective inductance, by an amount proportional to the fraction of the total resonating capacity supplied by the distributed capacity of the coil. (e.g. If a coil has effective inductance of 1 mh. and distributed capacity of 2 mmf., and resonance is established with 100 mmf. external capacity, then the true inductance will be 100 or approximately 2% lower than the effective inductance.)

102

To measure the distributed capacity of a coil the method is to note the resonant frequency when the coil is tuned by the large (1,000 mmf.) standard condenser, and then with the standard condenser removed, leaving only the Q meter output capacity plus the unknown distributed capacity. The relation between these two resonant frequencies, which we shall call F₂ and F₁, respectively, is as follows:

$$\frac{f_1}{f_2} = \sqrt{\frac{C_2 + C_d}{C_1 + C_d}}$$

Where C₁ = Q meter output capacity.
C₂ = C₁ + capacity of standard condenser.

C_d = Distributed capacity of coil.

Re-arranging this we get the expression for C_d:

$$C_d = \frac{C_2 - C_1 \left(\frac{f_1}{f_2}\right)^2}{\left(\frac{f_1}{f_2}\right)^2 - 1}$$

This is obviously a very unwieldy formula to have to apply each time a measurement is made, and to obviate the necessity for this it is desirable to plot a curve of the equation using the known values of C₁ and C₂, and choosing a series

APPLICATION FORM

I hereby make application for (renewal) (new) membership in the Association. One dollar is enclosed which entitles me to membership and subscription to XTAL for one year from date of application.

NAME

ADDRESS

CALL DATE

PROF. CERTIFICATE NO.
(other side may be used)

Season's Greetings

AND ...

A Happy New Year

TO CANADA'S RADIO AMATEURS AND SERVICEMEN WITH ...

MARSLAND PRODUCTS

- WIREWOUND RESISTORS OF ALL TYPES
- MICROPHONES AND MICROPHONE STANDS
- ELECTRICAL TESTING INSTRUMENTS

MARSLAND ENGINEERING COMPANY
KITCHENER, CANADA

K. B. X.

Prices:

From stock 3.5 or 7 M.C. Band, Nearest Spcfd. Freq. in stock.....	\$ 4.50
Within Plus or Minus 5 K.C.....	4.75
Within Plus or Minus 2 K.C.....	5.25
Integral Frequency	6.00
Filter Crystals, in types 2, 4 and 5 only—	
Frequencies 456, 465, or 500 K.C. Accuracy 1%.....	6.50
Accuracy .1%.....	10.00
Accuracy .01%.....	17.50

Prices Subject To Change Without Notice

Order direct or through your dealer

We make a specialty of repairing or replacing Broadcast crystals. Prices on Request.

20 ST. GERMAIN AVE. **K. BLEVIS Labs.** TORONTO, ONT.

SEASON'S GREETINGS

from LONDON'S new Radio Parts Wholesaler. Radio Service and Ham Equipment. Large unusual stock of War Surplus Transmitting parts . . . No Catalogue . . . Write us.

LANGFORD RADIO CO.- LONDON ONT.
246 DUNDAS STREET

of values for F_1/F_2 between about 3 and 9 the maximum possible value of F_1/F_2

will be when $Cd = 0$. Then $F_1/F_2 = \sqrt{\frac{C_2}{C_1}}$. Fig. 3 shows the curve plotted for the writer's instrument. In application it is merely necessary to measure F_1 and F_2 as above, calculate the ratio F_1/F_2 , and read the value of Cd directly from Fig. 3.

The measurement of the mutual inductance and coefficient of coupling between two coils is merely an elaboration on the measurement of self-inductance already described, and involves only some common sense and simple arithmetic. If two coupled coils are connected in series the overall inductance will be

$$L = L_1 + L_2 \pm 2M$$

Where L_1 = self-inductance of one coil.
 L_2 = self-inductance other coil.
 M = mutual inductance between coils.

If the fields of the two coils are aiding, then the sign of $2M$ in the above equation is positive. If the fields are opposing, it is negative. Thus to measure M we first connect the two coils in series and measure the total inductance in the ordinary manner. Then we reverse the connections to one coil (not both) and measure the inductance again. The difference between the two inductance readings is 4 times M ; or $M = 1/4$ of difference between the two readings. The coefficient of coupling "k" is then simply calculated from:

$$K = \frac{M}{\sqrt{L_1 L_2}}$$

Conclusions:

We have described the construction of an instrument that seems to possess everything that was aimed at. As a check on the performance a number of coils, chosen at random, have been checked on both this and a commercial Q-meter. In general, discrepancies between the inductance values measured on the two instruments were negligible. In most cases, and very noticeably on coils of low Q, the resonance indication on the magic eye was sharper than that on the indicating meter of the commercial instrument. Perfect agreement was not obtained with the Q measurements in some cases where the resonant impedance was high, until the measurement was made at a low level as previously

stated. In the latter case the discrepancies were of the order of 10% or less.

One should not be too disturbed about lack of high precision in the measurement of Q, since relative values of this quantity are all that are normally required. In the few cases where the actual value is required, an error of 10 or 20% is generally unimportant. Indeed, as anyone who has made extensive use of a Q-Meter knows well, the most useful function of the instrument is not to measure Q (in spite of the name "Q-Meter") but rather to find the inductance, capacity or resonant frequency of a tuned circuit; in which cases the Q-indicating meter is most commonly employed merely as a resonance indicator.

The writer contemplates some secondary uses for the instrument described. One obvious addition would be an audio oscillator (probably resistance-tuned) to modulate the screen of the 6AC7. The modulated r.f. output would then be useful for aligning receivers when the unit is used as a signal generator. Although perhaps not very practical, the VTVM circuit comprising the 6H6 and the magic eye could conceivably be used separately as a slideback VTVM.

Corrections:

As a last word the writer would like to correct one or two errors appearing in Part I. On page 8, in ninth line of second full paragraph "dampening" should be "damping". On same page, fifth line, middle paragraph in right-hand column, "left-hand" should be "right-hand"; sixth line from bottom of same paragraph "right-hand" should be "left-hand". Page 2, second last line of first full paragraph "insulating mounting" should be "insulation mounting - - -".

In Part II, page 15, the calculation given in the right-hand column contains a "3" that is meant to be a "cube". Rewriting, this should appear thus:

$$17.7 \times \left(\frac{1300}{708}\right)^3 = 109.8$$

COMMUNICATIONS DEPARTMENT

Plans are rapidly being formulated for many activities on the air. These will be in the nature of contests, both for C.W. and phone, traffic networks, DX information, monthly and quarterly QSO parties, emergency network operations, QSL bureau, etc., etc.

ACCURACY PLUS!

NEW CANADIAN SIGNAL GENERATOR



Incorporates every essential requirement to provide absolute accuracy and ease of operation:

- Designed to the most minute detail for highest accuracy, greatest stability, minimum leakage and good wave form.
- Big 7-inch dial. Knife-edge pointer. Excellent readability.
- Smooth vernier control permits accurate settings.
- Wide range. Four types of signals. Frequency range 135 Kc. to 40 Mc in five bands 1% accuracy. 400 cycle sine wave modulation. Dual calibrated attenuators. Variable modulation control. Welded steel cabinet.

Available through Jobbers. Write for complete details, illustration in colour and prices. Do it NOW.

Write for FREE Literature

Measurement Engineering

61 Duke St. Toronto WA. 2446

MEASUREMENT ENGINEERING

Announces

Its appointment as Canadian Distributor of CRYSTAL PRODUCTS CO.

Manufacturers of Crystal Units for the Amateur for Test Equipment and Communications

GOOD DELIVERY

Types 130-T & 131-T

Gas-filled, waterproof assembly. Metal J-5 and H-6 tubes. Crystal between fixed air-gap electrodes. Withstands atmospheric changes. Frequency ranges from 100-10,000 kc.

Typical Example

of the precision crystals manufactured by Crystal Products Co. Many other types are shown in catalogue—free to interested purchasing agents.

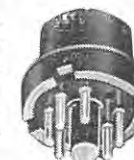

Write for FREE CATALOGUE to -

MEASUREMENT ENGINEERING

61 Duke St. - TORONTO - WA. 2446

AMATEURS!

Watch next month for important announcement of interest to every amateur.

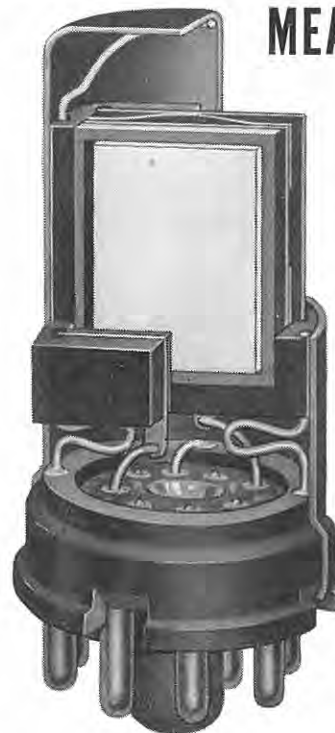

CLUB ACTIVITIES

The Canadian Lakehead Wireless Experimenters held their first post-war meeting recently, in the form of a dinner, at which twenty-five attended from Fort William and Port Arthur district. The new officers elected were: President, C. McDonald, VE3GS; secretary, Ray Greer; executive, P. J. O'Shea, VE3FW; Ray Godsalve, VE3RA; Harold Dow and Alex. Fulton. They report several of the gang ready to go, particularly on five, and the formation of an advisory council consisting of the original members of the club, whose duties will be to assist the newcomers.

The Victoria, B.C., Short Wave Club selected the "good news" night, Nov. 10th, to hold their annual meeting at a dinner at the Strathcona Hotel, with forty-one present. The newly appointed officers are: President, G. F. Green, VE5CH; vice-president, H. R. Hough, VE5HR; secretary, D. Scholes, VE5DY; treasurer, E. Lindley (by acclamation). Directors: G. R. Ball, VE5GB; E. S. Cross, VE5IE, and E. H. Cooper, VE5EC. Among those present were VE4's FM and MN; VE5's AAZ, AAM, ABU, ACE, ADB, ADY, AEF (the only YL), AFV, AGN, AHK, CH, DY, EC, GB, HR, IE, OS, PO, PX, RM, TZ, ex-5CO and ex-5EE (of spark days).

Most of the members of the Key Klik Klub, Toronto, are now on five. Their meeting nights are every second Friday at members' homes. They plan to meet soon at the Broadview Y.M.C.A. Five meters must be lucky, for nearly every member won a prize at the VEOPs ham-fest.

The Wireless Association of Ontario had nearly 150 present for their meeting Nov. 22nd, when Mr. G. A. Hanes gave an interesting lecture on 'scopes. Mr. R. Pickett, Aerovox Canada Limited, was to be the speaker for the meeting Dec. 14th, and Mr. Hanes, C.G.E., will speak at the Jan. 17th meeting on "F. M. and Police Radio." Meetings are held in the Electrical Building, University of Toronto, at 8 p.m., and everyone is cordially invited to attend, and bring a friend.

The British Columbia Amateur Radio Association held its annual meeting on Nov. 6th, when Fred Taylor, VE5HA, was re-elected secretary.

The West End Amateur Radio Club,

and the Totem Amateur Radio Club, both of Vancouver, report activities, as well as the Royal City Amateur Radio Club of New Westminster.

The Moncton Amateur Radio Club held its second reorganization meeting on Nov. 13th. The following officers were elected: President, W. E. Lockhart, VE1EL; vice-president, R. J. Hickey, VE1LP, and secretary, R. Grant, VE3AML. They now have thirty-six members, and hope to reach at least forty-five by Nov. 27th, the date of their next meeting.

The Halifax Amateur Radio Club will hold their next meeting on January 18, 1946, when an election of officers will take place. 1LZ, 1MZ, 1FB, 1NQ, and ex-1EF were appointed the committee to bring in a slate of officers. All Canada except VE2 was represented among the fifty-two who attended the November meeting. VO1R was also there. VE1JH is the present Secretary-Treasurer of the H.A.R.C.

WAVE

Now that we are on again, don't forget the Worked-All-Canada Certificate. Look up the rules and regulations in Sept. 1945 XTAL.

APOLOGY

During the past few months we have received a large number of letters from VE's residing in every province of Canada, as well as a few from outside the country. They've all been swell letters, too, giving us the dope we asked for in connection with service records and addresses, and usually adding a word or two about how glad they are to see a real Canadian ham organization under way. We only regret the fact that we haven't been able to answer each one individually due to lack of time and staff, but take our word for it, it's one of the day's chief pleasures to open a new batch of mail and find out what the boys have been doing during the Great Silence. We are trying to publish as much pertinent dope as possible in XTAL, so keep 'em coming and accept our thanks. In future, we hope to keep up with our correspondence.

**WESTERN ONTARIO
HAM HEADQUARTERS**

- All types of Ham Equipment.
- Free Competent Advisory Staff.
- Orders shipped day received.
- Come in and browse around.
- Ragchew with VE3ALX and VE3AAO.

SEASON'S GREETINGS and 73

**Frank Gerry & Co.
LIMITED**
opposite Market Square
LONDON ONTARIO



A. P. H. BARCLAY

The strong position held in the electronic field by Rogers Majestic Limited, of Toronto, has been further strengthened by A. P. H. Barclay, B.A., MSc., who joins the company as head of its Tube Engineering and Application Division. This appointment has just been announced by J. R. Warren, chief engineer of Rogers Majestic Limited and Rogers Electronic Tubes Limited.

Mr. Barclay comes to his new post with excellent qualifications. At McMaster University, he specialized in chemistry and physics, graduating with a degree of B.A. Post-graduate studies in communications and physics at Cornell University won him his MSc. This fine academic record is matched by practical experience with internationally famous electronic industries in the development and application of sound systems, commercial broadcast equipment and general communication devices. In the course of his work, Mr. Barclay assisted in the development of the special radio equipment used during the visit of their Majesties to Canada.

As if working all day on electronic problems were not enough, one of Mr. Barclay's hobbies is radio; this is balanced by golf and revolver shooting.

One of the most enthusiastic supporters of a Canadian amateur radio society is Harvey Reid, VE3ADR, of Toronto, judging from the many letters received by VE3ACL. As Flight Lieut. Reid, R.C.A.F., he spent three years as radar officer in England, Egypt, Cyprus, Sicily, and Italy. Unfortunately radar had not progressed to the point where it could detect the approach of the malarial mosquito (just the DeHaviland variety), and six feet three of ham presented an irresistible target. Experts have since expressed the opinion that Harv. was in a weakened condition to start with, having been bitten by the radio bug many years earlier. In any case, VE3ADR is now home at 371 Willard avenue, after two years' hospitalization, just barely in time to hit the air with a T40! Nice going, Harv!



HARV. REID, VE3ADR

STARK

Electrical Indicating Meters
for Radio "HAMS"



- Voltmeters
- Microammeters
- Milliammeters
- Millivoltmeters

Illustrated: Model 604, 3½" Rectangular Bakelite, 0-1 Milliammeter.

STARK
Electronic Instruments Ltd.
161A KING STREET WEST,
TORONTO, CANADA

Calling All "HAMS"!
Welcome Back

It is our pleasure to be at your service

as HALLICRAFTER DISTRIBUTORS we are accepting orders for models S20R, S22R, SX25, SX28A, S39, 60 or 25 cycle.

STOCK NOW AVAILABLE

Canadian Electrical Supply Co. Ltd.

Wholesale Distributors

MONTREAL
285 Craig St. W.
LA. 7151

TORONTO 1
387 Yonge St.
AD. 6366

Resonant Transmission Line Sections - Part II

By A. P. H. BARCLAY*

The first part of this article attempted to give a simplified outline of the general characteristics of Resonant Transmission Line Sections. This second part of the article will outline some of the applications which make use of the characteristics already enumerated.

The applications which will be discussed are as follows:

- (1) As impedance matching devices.
- (2) As harmonic suppressing devices.
- (3) As transmission line supports.
- (4) As reactance elements.
- (5) As frequency control elements.

It will be evident from the first section of the article that knowledge of the magnitude and position of the standing waves on a transmission line—will indicate the degree of match which exists. The "voltage standing wave ratio" (VSWR) is most often measured, but the "current standing wave ratio" (ISWR) may also be used in measuring, remembering that a voltage maximum always coincides with a current minimum and vice versa. The ISWR and location of the maxima and minima may be measured with thermocouple meters, crystal rectifier meters or diode rectifier meters suitably coupled to the transmission line. However, the subject of match checks by means of standing wave measurements and detectors for accomplishing same cannot be gone into in detail since it is beyond the scope of this article and is

worthy of separate treatment. A few points in connection with the use of VSWR measurements will be brought out as we progress. When there is unity VSWR on a transmission line, we have the matched condition. Fig. 9 shows that a fair VSWR may exist without much power being lost by reflection.

Before proceeding with our investigation of applications, it should be pointed out that most of the information given is in terms of open-wire lines, since it is felt to be of more interest to amateurs, but in most cases it will be obvious how coaxial lines could be similarly used.

(1) As Impedance Matching Devices.

One of the most useful applications of resonant transmission line sections is as stub lines in matching. In connecting a transmitter to an antenna by a transmission line, for example, it is desirable to have a reasonably good match between the antenna and transmission line so that there will be a good transfer of power from the transmission line to the antenna and losses will be kept to a minimum. (See Fig. 9). Both open and shorted stubs may be used, although the shorted stub is preferred, due to its lower radiation losses and since it can be made more solid mechanically and is more readily adjusted. Fig. 10 shows the general arrangement used. L1 can be looked upon as a resonant section of transmission which is terminated in an impedance

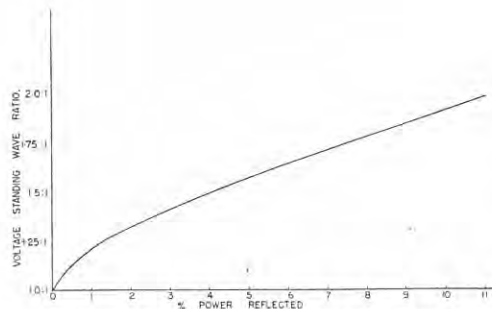

FIG 9 VOLTAGE STANDING WAVE RATIO VS REFLECTED POWER

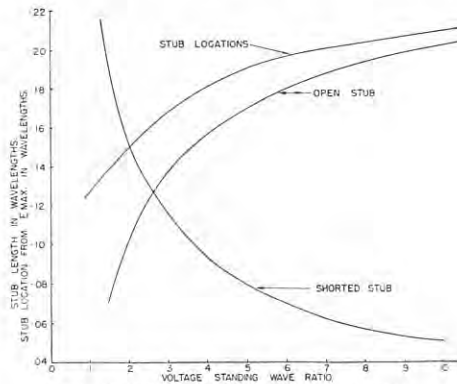

FIG 11 DETERMINATION OF STUB LENGTHS AND LOCATIONS IN IMPEDANCE MATCHING

*107 McRae Drive, Leaside, Ont.

"SEASON'S GREETINGS

FROM
HAM HEADQUARTERS"

VE3XB



... and a **NEW YEAR'S OPPORTUNITY!**



**NEW
SX28A
HALLICRAFTER
RECEIVER**

The owner of a Hallicrafters' Super Shkyrider, Model SX-28A short wave communications receiver stands on the threshold of a whole new world of radio. It is the world's finest standard and short wave broadcast receiver—used by the armed forces, thousands of amateur operators, commercial services and government agencies. It provides controlled operation under all circumstances.

Write for Illustrated Literature

WHOLESALE RADIO

CO. LIMITED

1133-37 Bay St.

Toronto, Ont.

Zs. This impedance may be made up of pure resistance or some resistance and some reactance. L1 is made of such a length that the impedance transferred to A.B. is part pure resistance and part reactance, the resistance being equal to the Zo of the lines. L2 is then put in at A.B. and made of such a length that it will have a reactance equal to, but opposite in sign to the transferred reactance. These two are in resonance and result in a high impedance in parallel with the line impedance, thus do not load it down. The net result is a matched load for the line.

It is rather difficult to make such a match by trial and error. Since this is a practical problem, a systematic approach to the solution of such a problem will be presented. With the system connected up and power being fed to the antenna, an R.F. voltage indicator is used to locate the voltage maximum point nearest to the antenna. Moving toward the transmitter end of the transmission line, a voltage minimum will be found. From a comparative measurement of these two, the standing wave ratio may be found.

$$\text{Voltage standing wave ratio} = \frac{E \text{ max.}}{E \text{ min.}}$$

From Figure 11, the location of the stub on the main and its length may be found. If a shorted stub is used, its location is between the maximum and the transmitter. If an open stub is used, its location is between the maximum and the antenna.

Some slight adjustment of the stub position and length may be necessary to take care of experimental errors. These slight adjustments are made until the standing wave ratio is of a reasonable value (Fig. 9). As an example, let us suppose that a transmission line with a characteristic impedance Zo is connected to an antenna with an impedance of Zs and when the VSWR is checked it is found to be 6:1, i.e., the ratio of E max. to E min. is 6:1. From Figure 11, it can be determined that a shorted transmission line section to correct this mismatch should be 0.07 wavelengths long and located 0.197 wavelengths from the voltage maximum nearest the load, and between the max. and the transmitter. If it were desired to use an open-circuited transmission line section, it would be 0.18 of a wavelength long and located 0.197 wavelengths from the voltage maximum near-

est the load but would be between the max. and the antenna. From previous information given, the physical lengths for a particular frequency may be determined. Unfortunately, the units were not specified in one formula previously given to correct.

$$\text{One Wavelength (in feet)} = \frac{984 \times K}{\text{Frequency (in Mc.)}}$$

It is probably undesirable to express this in terms of wavelength and frequency in the interests of uniformity, but since it is more easily handled, this is done in the interests of simplicity.

A non-shorter quarter-wave resonant section may be used as an impedance matching device since, as pointed out before, the input impedance of such a section is determined by the ratio of its own characteristic impedance squared to the load impedance. Thus, in practice, if it is desired to connect two transmission lines of different characteristic impedances and still maintain a matched condition, an open quarter-wave resonant section may be connected between the two. For example, it is desired to connect a 600 ohm line to a 200 ohm line.

The input impedance at the terminals of the quarter-wave section will be 600 ohms and the impedance at the output terminals of the quarter-wave section will be 200 ohms. Therefore

$$600 \text{ ohms} = \frac{(\text{Zo of quarter-wave section})^2}{200 \text{ ohms}}$$

or Zo of quarter-wave section
 $\sqrt{600 \times 200} = 346 \text{ ohms}$

for practical purposes, 350 ohms. A check of the VSWR on the two transmission lines will indicate how well the system has been matched. Similarly, if it is desired to connect a transmission line to an antenna whose input impedance shows no reactance or only a very small amount, a quarter-wave resonant matching section may be used. For example, if it is desired to connect 600-ohm line to a 73-ohm dipole, which has been cut to proper length to have a very low reactance component, then the characteristic impedance of the quarter wave matching section would be $=\sqrt{600 \times 73} = 210 \text{ ohms}$.

Once again a check of the standing wave on the transmission line will indicate how well the system has been matched. In designing such a section, Fig. 6 of Part I, may be used to find suitable conductor diameter and spacing to give a characteristic impedance of 210 ohms to

We are very pleased to hear Canada's amateurs back on the air. Your magnificent service, for over six years, to Canada and the Allied Nations both in the services and in war industry cannot be too highly emphasized.

• We extend also, Christmas Greetings, and a wish for 1946 . . . the return of your lower frequency bands.

T. S. FARLEY, Limited

HAMILTON, ONTARIO

"Manufacturers of all types of Radio Coils"

Attention, VE's!

When you come to Buffalo, be sure to drop in at DYMAC INC.—the largest radio parts and equipment distributor in the Western New York area. Here you will find all kinds of Ham gear to gladden experienced Hams' hearts. A cheerful welcome awaits you!

DYMAC Inc.

WHOLESALEERS OF RADIO PARTS AND TUBES
DISTRIBUTORS OF ELECTRONIC EQUIPMENT

2329-31 MAIN ST. (near Leroy), BUFFALO 14, N.Y.

PARKSIDE 2300

the section. The length would be obtained from

$$\text{Wavelength (in feet)} = \frac{984 \times K}{\text{Frequency (in Mc)}}$$

So a quarter wavelength section of open wire line for 50 megacycles would be $\frac{984 \times .975}{50} \times \frac{1}{4} = 4.8$ ft. approx.

Good dielectric spacers would be required. Since a quarter wave shorted resonant line section has high impedance at its input terminals and very low impedance at the short end and varying values in between, it may be also used for effecting a match between lines having two different impedances. The line of lower impedance would be connected to the end nearer the shorting bar and the higher impedance line to the end nearer to the open-circuited end. This type of circuit is similar to an impedance matching circuit using an L/C resonant circuit and tapping off the coil. See Fig. 12A.

To transform from a low impedance to a high impedance, a quarter-wave resonant shorted section may be used as in Fig. 12C.

(2) As Harmonic Suppression Devices

A short-circuited quarter-wave section of line, we have seen, has high impedance at its input terminals when its resonant wavelength is applied. If we halve the wavelength (this is second harmonic wavelength) we see that at the new wavelength the short circuit section is a half-wavelength long. Now a short-circuited half-wavelength resonant section has low impedance at its input terminals, so acts as a short circuit for this wavelength. If we quarter the wavelength (this is the fourth harmonic wavelength) the shorted section is a wavelength long, and a shorted full wavelength resonant section likewise has low impedance at its input terminals, so also

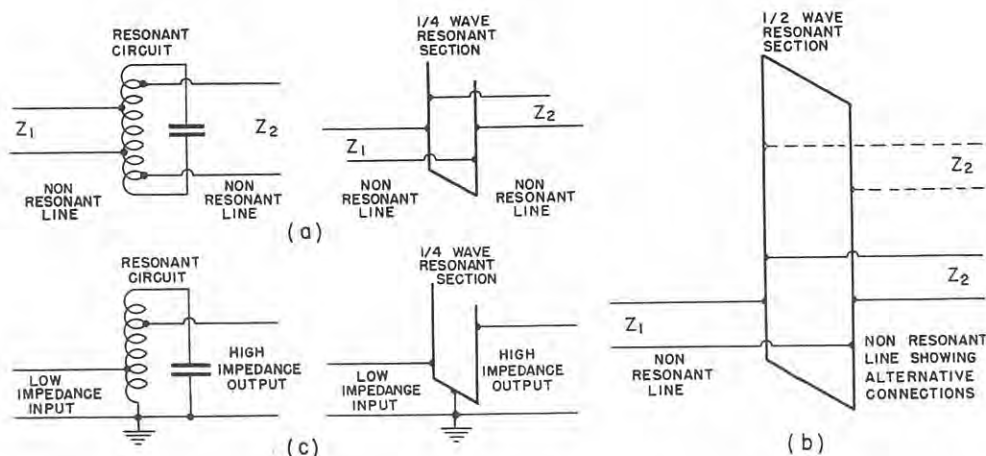

FIG. 12

In a similar manner, a half-wave section shorted at both ends may be used. This scheme may be more suitable for mechanical mounting since both shorting bars may be grounded. It is really equivalent to two quarter-wave shorted sections in parallel, and the match is obtained in the same manner as for the quarter-wave section. It should be noted that there are two points where the outgoing lines may be connected and this may have use in applications where a 180° phase change is required, since a 180° phase change can be obtained by using the upper of the two possible matching points. See Fig. 12B.

acts as a short circuit at this wavelength. Carrying this study out further, we find that for any even harmonic wavelength a section of line which is a quarter wavelength long at the fundamental wavelength, will have a low impedance at its input and be equivalent to a short circuit. This means that a quarter wavelength long shorted resonant section put across a transmission line will look like an open circuit to the fundamental wavelength, but will short out all even harmonics of the fundamental wavelength.

A quarter-wave open-circuited resonant section of line in comparison with the

ALL AMATEUR Transmitter Contest

INAUGURATED BY

TAYLOR TUBES

Co-Sponsors

AEROVOX — AMPHENOL — BARKER WILLIAMSON —
BLILEY — GOTHARD — IRC — JOHNSON —
SOLAR — UTC

Win Your "Dream" TRANSMITTER

Taylor Tubes and the co-sponsors have inaugurated this contest in order to determine what amateurs are planning on using in their new transmitters. There are two power ranges—0 to 250 watts input and 251 to 1000 watts input. The winner in each class receives the Transmitter, completely built, that he designed plus \$1,125 in Victory Bonds. The Official Entry Blank gives full details and must be used. Get your Entry Blank at once from your favorite Radio Parts Distributor.

See November issue of QST for announcement of Taylor's new High Frequency Tube—the "Tuffy" TUF-20.

"More Watts per Dollar"

TAYLOR TUBES, INC., 2312 WABANSIA AVE., CHICAGO 47, ILL.

TORONTO HAMFEST

On November 16th the Toronto hams celebrated the return to the air by staging a hamfest at the Royal York Hotel. Owing to the congested conditions in the Toronto area, attendance was limited to 150. XTAL is sorry, too, that the last issue was late in reaching every one with hamfest publicity, but the grapevine sufficed to have a maximum gathering.

Activities started in the early afternoon, where many became re-acquainted, and mid rag-chews looked over the displays of equipment, as well as fondling many formerly secret radio tubes loaned by Research Enterprises Limited.

Promptly at 7.15, for perhaps the first time in banquet history, everyone was seated to partake of roast chicken and associated victuals. S/L T. S. Carpenter, VE3BD, was the able M.C. and called upon S. B. Trainer Jr., VE3GT, Vice-President of C.A.R.O.A., and W/C Donald Gunn, VE3EF, S.C.M., Ontario, to present the latest information regarding rules and regulations pertaining to the return to the air.

Interesting R.C.A.F. and National Film board films were shown, and afterwards many comments were made about some of the amateurs who were in the films. F/ Chas. Boughner, M.B.E., VE3IM, straightened the discussion out by admitting to be in one film himself, and spoke most praisingly about the fine job the R.C.A.F. hams had done, both in radio and maintenance.

Following the films a prize draw was held and thirty-eight were fortunate to get one of the following items: Bug key, \$5 vouchers, tester analyzers, modulation transformers, dummy antennae, transmitting condensers, 400-watt power transformers, 866 filament transformers, crystals, 100-foot lengths coaxial cable, HF-100s, HF-200s, 813s, etc., etc. Then as a finale a door prize of an 807 was presented to each person.

The committee wishes especially to thank the following for their generous prize donations: Alpha Aracon Radio Co. Ltd., K. Bleviss Labs., Canadian Electrical Supply, Canadian General Electric Co. Ltd., Hammond Manufacturing Co., Stark Electronic Instruments Ltd., Radio Trade Supply Co. Ltd., Canada Wire & Cable Co. Ltd., Wholesale Radio Co. Ltd., Rogers Majestic Ltd.

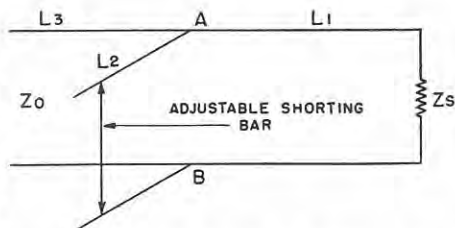

FIG 10—MATCHING WITH A STUB LINE

RESONANT LINES

(Continued from previous page)

quarter-wave shorted resonant section of line in comparison with the quarter-wave shorted resonant section has low impedance at its input terminal when its resonant wavelength is applied, and at odd harmonic wavelengths has high impedance. Hence if we put one of these sections across the transmission line, it would short out the fundamental and allow the harmonics to be transmitted. However, if we put it in series with one side of the line, it accomplishes the desired results in offering low impedance to the fundamental and transmits it down the line. The even harmonics are blocked due to putting high impedance in series with the line at their particular wavelengths.

Applications (3) As transmission line supports, (4) As reactance elements, and (5) As frequency control elements, will be described in Part III in the next issue of XTAL.

VE TIME FOR QSO's

As more and more of us get on 28 mc. let's renew acquaintances with fellow VE's. Every Sunday from 12 to 3 p.m. E.S.T. has been set aside for VE QSO's. Let's make them also 'phone-cw contacts. Simply call "CQ VE". Please send in your logs for publication in XTAL. Here is a chance to get off to a good start for a VE to be the first to win the "Worked All Canada Certificate". And, also, if you don't work them, let us know whom you've heard and on what spot in the band.

The next issue of XTAL will be out soon. Have we heard from you?

ERIE STYLE 554 CERAMIC TRIMMER

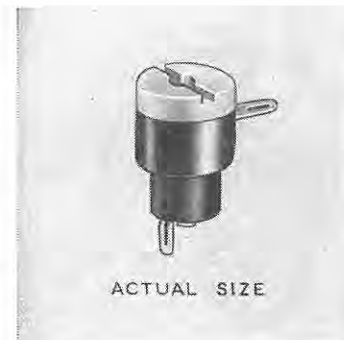

Voltage Rating: 350 volts D.C.

Flash Test: 700 volts D.C. for 15 seconds

Initial Q Factor at 1MC: 500 minimum

Initial Leakage Resistance: 10,000 meg. min.

HERE is a new ceramic trimmer that's unique in design, extremely compact, with desirable capacity ratios and is priced for a wide range of applications in broadcasting and high frequency bands.

The Erie 554 trimmer employs a ceramic dielectric and is available in nominal temperature coefficients, zero,—300, and —750 parts/million/°C. In the N750 coefficient, capacity range of 8-50 MMF is available. Corresponding ratios in lower capacities are furnished with zero and N300 coefficient.

Capacity change is essentially constant per degree of rotation, and full range is covered in 180° rotation.

The metal rotor completely covers the stator track. Contact surfaces of both rotor and stator are lapped, providing a high degree of stability, preventing dust or other foreign matter from affecting the performance characteristics of the unit, and keeping noise level to a minimum at high frequencies. Electrical characteristics are given above.

These trimmers are firmly held in place in a D hole in the chassis by means of a multiple-tooth spring clip, furnished with the trimmer.

For complete information contact our nearest representative or write us direct

ERIE RESISTOR OF CANADA LIMITED

128 PETER STREET

TORONTO 2B, ONT.

Factories: Toronto, Ont.; London, Eng.; Erie, Pa.

Letters to The Editor

Saskatoon, Sask. . . . it gives me lots of pleasure to see our magazine in operation once again after the lay-off due to the war . . . "Jack" Proctor, VE4EM.

Toronto, Ont. . . . hope that subsequent issues of XTAL have some 112 mc. and higher gen . . . P. B. Brodribb, VE3AON.

Victoria, B.C. . . . appreciate receiving past issues . . . H. R. Hough, VE5HR.

Truro, N.S. . . . How about some hints on good transmitting antennae? . . . Dick Rector, VE1KN.

Florence, C.B. . . . It was with considerable delight that I picked up my first copy of XTAL, which I have been looking forward to for so long . . . John Bond, VE1CN.

Penticton, B.C. . . . I am enclosing two dollars, one of which is to pay for my membership in the Association, and the other is a donation to get things started . . . Terry Lynch, VE5CS.

Tyvan, Sask. . . . "Power, Dollars and Sense," in the last XTAL, should be seriously considered by every reader. During the depression there were scores of fleapower rigs on these prairies, powered by B batteries, vibrators, 135-volt dynamotors, etc. They were heard and worked by hundreds in many countries because they were compelled to get every available fraction of a watt out of their receiving tube finals into a skywire that would radiate. As 4GA used to say, introducing a fleapower station: "He ain't very big, but he's got a lotta 'fishency'." Look for him on . . . J. Stewart Houston, VE4KJ.

Glance Bay, N.S. . . . For many years I've felt we should have a 100 per cent Canadian Amateur organization . . . one that was "by and for" the Canadian alone . . . E. M. Rowe, VE1BK.

Toronto, Ont. . . . I would like to see some articles on test equipment, such as tube testers, condenser testers, test oscillators and low cost scopes . . . N. M. Burford, VE3RQ.

Sarnia, Ont. . . . I have been reading QST lately and the urge to get in touch with the old ham game again had become too much, and then I saw a copy of XTAL and that finished it . . . G. E. Hare.

Orillia, Ont. . . . Thanks for XTAL. In my opinion it is just what the doctor ordered and I hope the gang get right behind it, and put it over the top in a big way . . . C. M. Brooker, VE3AQY.

St. Thomas, Ont. . . . I heartily agree with Harvey Reid, 3ADR, that the Two-Tube Receiver circuits should be left out of a magazine that is published for the boys that cut their eye teeth on such sets years ago . . . Ray Crooker, VE3HG.

ANTENNA COUPLING

(Continued from page 14)

It is doubtful if this antenna could be tuned on 14 Mc because the plate to ground stray capacity would likely be more than the 12 mmfd. required in the tank condenser. Therefore on this band the antenna would be shortened to say 20 feet and the following values would hold (RL=2000).

	14 Mc
Length	.285 wavelengths
Resistance	68 ohms
Reactance	+90 ohms
Rt=68+2=	70 ohms
Xc	380 ohms
C	31mmfd
XL	365 ohms
Xt=365-90=	275 ohms
L	3.1 microhenries

Thus from the above analysis, it appears that for this antenna and assumed load impedance, a capacity range from 31 to 390 mmfds. and an inductance range from 3.1 to 14 microhenries is required. One solution, shown in Fig. 5, uses a roller coil having a total inductance of 15 microhenries, minimum approximately zero. (27 turns No. 14 Bare Copper Wire, 9 turns per inch on a 1 3/4" dia. form). The capacity consists of 10 fixed condensers, having values of 10, 20, 35, 50, 75, 100, 200, 300, 400, 500 mmfds. For power outputs below 20 watts, these can be small 1000-volt mica condensers of the postage-stamp size, mounted on a standard Oak rotary switch. This combination is somewhat smaller than the 500-mmfd. variable condenser which could replace them if desired.

The next article will describe the design of pi networks.

HAMS . . .

are you receiving your copy of



VOL. 16, NO. 1

JANUARY,

50c per year in U.S.A.

60c per year in Canada

Capacitor Impedance and Resistance Measurements

PART II

By the Engineering Department, AeroVox Corporation

AT AUDIO AND RADIO FREQUENCIES
THE impedance of electronic circuit components may readily be measured at power-line, audio, and radio frequencies. A variety of instruments and methods makes this possible. For any impedance measurement, there will generally be available in each laboratory or shop a sufficient number of instruments to allow choice of method. This article will describe the most important instruments and methods from a practical point of view.

VOLTMETER-AMMETER METHOD

The simplest method of measuring impedance is an application of Ohm's Law for ac. A known voltage is applied across the unknown impedance, which may be either capacitive, inductive, or a combination of the two, and the resultant current through the impedance measured. The impedance value may then be calculated from Ohm's Law $Z = E/I$, where Z is

expressed in ohms, E in volts, and I in amperes. Apparatus required includes a source of alternating voltage of desired frequency, ac voltmeter, and ac ammeter (see Figure 1). Impedances may be measured by this method over a wide range of frequencies. However, it is not advisable to employ test frequencies higher than about 50 kc, since at radio frequencies appreciable error is introduced by stray capacitances and skin resistance effects. Between 10 and 50 kc, greatest accuracy will be obtained with a vacuum-tube voltmeter and high-frequency type thermocouple ammeter.

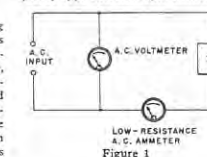

Figure 1

If the test-signal source is arranged to supply a continuously variable voltage to the test circuit, a wide range of impedance values may be covered. This is true because the input voltage may then be adjusted to pass a readable amount of current through any impedance. The test voltage may be obtained from the power line, a transformer secondary, or an oscillator. Test voltage may be adjusted by means of a potentiometer, attenuator, or variable auto-transformer (Variac).

The method of Figure 1 may be applied to yield direct indications of impedance in the following manner: If the signal voltage is always set to give the same ammeter reading (e.g., center scale), the voltmeter scale may be graduated directly in ohms impedance. In operation, the unknown impedance is connected into the circuit and the voltage raised from zero to the level required to deflect the ammeter to a reference point. The impedance is then indicated directly by the specially calibrated voltmeter dial.

AEROVOX PRODUCTS ARE BUILT BETTER

Copyright © 1945, AeroVox Corporation

Copyright © 1945, AeroVox Corporation

If not
Send your name address and Station call letters to

AeroVox Canada Limited

HAMILTON

ONTARIO

REPORT FROM NATION

(Continued from page 18)

chatty note from ex-3MW living at 291 Queen . . . would like to know more Sarnia hams . . . 3APC is about to crank up a new rig in Preston . . . 3APV in Port Dover likes the prospects of opening up again . . . 3BAE, who rides the Patricia Bay radio range, corralled F. W. Sealey of Vancouver, who is of course now branded . . . as a ham-to-be . . . 3AXT, now in Murrayall with RCA-Victor has some good dope labelled "XTAL, for the future use of" . . . 3BAV, dizzy after four years of sq-waves, sync. pulses, and saw-tooth wave forms of radar, sez the Q code seems a strange and forgotten language . . . funny how easy it comes, though, OM . . . 3AQY in Orillia met at least a hundred hams in his travels overseas with R.C.A.F. . . . swell to see you back, Milt . . . 3AIO has 50-watt commercial job set to go . . . 3ANU, now in Mountain San at Hamilton (Evel Bldg 3-9) had tough break but . . . like lotsa hams . . . has the heart . . . to come back and pound brass again, but soon . . . come on, fellas, let's write a letter . . . George White's his name . . . let's give him a hand . . . it's Xmas . . . 3LO intends to renew license as soon as possible . . . 10I in Sydney Mines flitted from destroyer to destroyer to civvy street and now to hamming . . . quick, Henry, the key . . . ex-3HG of St. Thomas, 71 months the property of R.C.N.V.R., is back in Canada again and wants good solid technical articles in XTAL . . . was at a meeting of hams in Belfast, Ireland . . . they had 'em weekly all during the war! . . . 3PK ready to shoot with 350 watts on 14 mc soon as he gets home from Trenton . . . 3AZJ at the Lakehead enjoys thought of getting back into harness again . . . another name that sorta appeals (you'd think we were BCL's) is—Allied Broadcasting Corp. Ltd. out on Wolfe Island CKWS, here we find ex-3AE (how I wish I had it back) Charlie Fitzgerald, 3AKE, a Watford old-timer of the gud ole daze . . . welcome, Chas. . . Brrrr—on a nite like this—The Arctic Radio Corp., CFAR . . . well, mebbe this one will appeal about next Field Day in August . . . sure we're gonna have a Field Day . . . well, anyway, 5DV tells of some emergency work he was called upon to do working out

HAM-ADS

Hammond 265 Plate and 267 Fil. xfmsr 60 cyc. Never used. \$5 takes them. VE3AZY, 500 St. John's Road, Toronto.

What is the "Glacier"?

For Sale, 1 kw. transmitter using 2-805, 2-806, 2-872, etc. Mrs. M. A. Paull, 397 Bleecker St., Toronto. RA7407.

HAM GEAR

of the late VE3BF

Transmitter with T40 in final, grid modulated, complete with 1000v. 25-cycle power supply, crystal mike, and misc. items. TRE home-made receiver, radio correspondence course, 2 type 211 tubes, miscellaneous ham gear. Will sell units separately.

ART HOLMES, VE3IK

28 Concord Ave., Toronto, Ontario
Phone OLiver 2386

WANTED—Alternator, single phase, 60 cycle, 110-220 volts, 1½-2 KVA. C. Glasrud, VE4GU, Mazenrod, Sask.

FOR SALE—100-watt xmtr, 25 cycle, rack and panel, phone and C.W., 203A final, plate mod., complete less mike \$100. A. H. K. Russell, VE3AL, 424 Rosemary Rd., Toronto. MOhawk 0464.

WANTED—28 Mc. bandsread coils for FBX-A. VE3AGC, 170 Park W., Chatham, Ont.

of CFAR in Flin Flon . . . he nearly was an emergency case himself . . . be-cuz of a blizzard that all but marooned him until freeze up . . . for six weeks in an isolated gold mine camp miles from nowhere . . . Brrrr . . . Eiderdown, here we come . . . at least until our next QSO . . . but just for a fleeting second before we go . . . let's pause and be thankful . . . that THIS Christmas, be it spent in our Homes, Abroad, or in Hong Kong, is the epitome, Peace, and that years hence the Christmas of 1945 will be the subject of many warm-hearted gatherings of former comrades-in-arms . . . and so . . . we hope yours is Good . . . We hope that it is Full . . . Full of green holly, red berries and white snow; of the sound of rustling paper, and Bells, and Singing; of the rich smell which is a blend of wood smoke and pine boughs and Plum Pudding . . . To ALL of YOU, from the hearts of XTAL go the warmest Greetings.

Westinghouse

RADIO TUBES

The part radio tubes have played during the past six years is matched in dependability by the tubes now coming off the line for peace-time users of all types of Westinghouse electronic products.



Canadian Westinghouse

Company Limited

HAMILTON

ONTARIO



Season's Greetings

— O. M. —

HALLICRAFTERS RECEIVERS, MODELS SX28A—SX25—
S20R—S22R—S36A—S39 AVAILABLE FOR
DELIVERY IN JANUARY

25 and 60 Cycles

Write for Descriptive Folder and Prices

PLACE YOUR ORDERS NOW TO ASSURE PROMPT
DELIVERY



ALPHA ARACON

Radio Company Limited

"Canada's Foremost Radio Supply House"

29 ADELAIDE STREET WEST TORONTO 1, ONTARIO
Telephone ADelaide 1312

5 YEARS AHEAD OF ITS TIME

FM
AM
CW

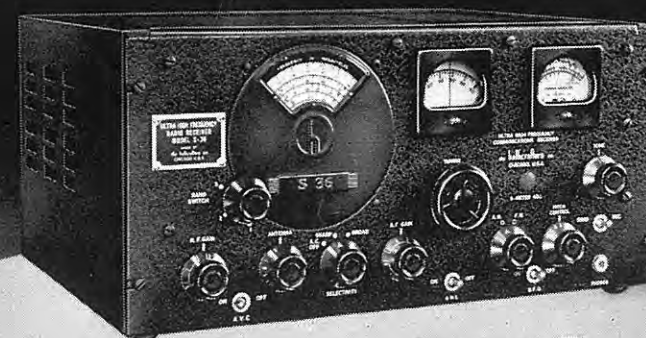

27.8 to 143 Mc
Covers old and new FM bands

hallicrafters Model S-36

EXACTLY five years ago—in 1940—Hallicrafters introduced a very high frequency communications receiver with a range of 27.8 to 143 Mc. This model was clearly five years ahead of its time in its anticipation of new and exciting possibilities for superior performance on the higher frequencies. Today Model S-36 stands by itself as the only commercially built receiver covering this range. It is outstanding for sensitivity, stability, high fidelity. With its extraordinary VHF versatility it is ready for immediate application in the ever widening fields of FM and higher frequency development work. Engineering imagination at Hallicrafters is reaching out beyond the next five years, beyond the present known limits of radio technique so that Hallicrafters equipment will continue to be always ahead of its time, above and beyond your best expectations.



hallicrafters RADIO

THE HALLICRAFTERS COMPANY, MANUFACTURERS OF RADIO AND ELECTRONIC EQUIPMENT, CHICAGO 16, U. S. A.

BUY A WAR BOND TODAY!